



Infrico

· C A T A L O G U E ·

frIBuffet

20/23



Valable pour tout le catalogue:

Prix valables sauf en cas d'erreur typographique ou de changement de tarif.

Étiquette énergétique disponible dans les fiches produits sur notre site fribuffet.com

Photos non contractuelles

Les caractéristiques techniques et la conception peuvent être sujettes à modifications, sans préavis

Les données techniques peuvent varier et seront actualisées dans les fiches techniques du produit, disponibles sur le site web.

2023

Nous vous présentons

friBuffet

La nouvelle ligne Infrico

Nous vous présentons la nouvelle marque de la famille Infrico : Fribuffet.

L'un de nos principaux piliers a toujours été l'innovation la recherche de solutions aux différents besoins de nos clients en veillant toujours au design, à l'efficacité et au respect de l'environnement.

Le respect de l'environnement. Aujourd'hui, le secteur HORECA se trouve dans un processus de renouvellement et nous nous y engageons.

Fribuffet, notre nouvelle marque, se concentre sur l'amélioration du service de buffet et de nourriture préparée pour les plats chauds et froids en maintenant toujours la qualité et les propriétés des aliments. En outre, nous nous engageons à assurer le confort des utilisateurs finaux grâce au design des différents types de mobilier.

Chez Infrico, nous avons créé différents meubles pour répondre aux besoins de chaque établissement.

C'est pourquoi nous trouvons des éléments de chauffage ou de refroidissement et une grande variété d'éléments et d'accessoires qui complètent cette nouvelle ligne. Avec pour mission principale de maintenir l'intégrité et les qualités de chaque aliment, ainsi que de les présenter de la manière la plus appétissante. Le tout toujours avec la qualité et la technologie maximales du groupe Infrico.

Fribuffet est une valeur sûre en matière d'innovation et de design avec une marque espagnole inspirée par les plus hauts standards de qualité, d'efficacité énergétique et de respect de l'environnement.

Chez Infrico, nous avons investi beaucoup d'efforts dans la R+D+I en appliquant les dernières technologies dans la fabrication des équipements Fribuffet, en offrant différentes solutions aux besoins du marché.

Le Groupe Infrico est une entreprise globale qui nous permet de servir les entreprises du monde entier, en offrant un service sur tous les continents et en couvrant les besoins des clients les plus exigeants.

Index



Pag. **4** /
Entreprise

Pag. **10** /
Contrat

Cap. **1** /
Basic Buffet
Pag.14

Cap. **2** /
Gastrobuffet
Pag.30

Cap. **3** /
Encastrables
Pag.58

Cap. **4** /
Self Service
Pag.78

Cap. **5** /
Chariots pour le
chaud et le froid
Pag.98

Cap. **6** /
Éléments Neutres
Pag.108

Cap. **7** /
Accessoires
Pag.128

Pag. **142** /
Délégations



Entreprise

INFRICO est un fabricant espagnol leader dans la production d'équipement de réfrigération commerciale. Une technologie de pointe et une qualité certifiée sont les garanties sur lesquelles est fondé notre engagement d'innovation : élaborer les meilleures idées et solutions pour chacun de nos clients. L'entreprise se situe parmi les entreprises leaders du secteur, avec une position très avantageuse par rapport à ses concurrents quant au volume de marché et à sa présence sur le territoire français. Avec 13 délégations

sur le territoire espagnol et 16 à l'étranger, Infrico répond aux besoins de ses clients de manière proche et en temps opportun, avec un système de production flexible et efficace. En outre, dans le cadre d'un engagement ferme en faveur de la stabilité et du bien-être social, plus de 90 % des travailleurs sont des employés permanents. Infrico possède le **certificat d'origine espagnol (O.E.C.)** qui atteste que ses produits sont fabriqués en Espagne ce qui en fait la première entreprise du secteur à obtenir ce label.

Les centres de production de Lucena, dans la province de Cordoue, sont l'une des installations industrielles les plus modernes d'Espagne. Trois usines, Infrico, Infrico Supermarket et Impafri, d'une superficie totale de **160 000 mètres carrés pour la production**, la logistique et les bureaux.



160.000 m2 dédiés à la fabrication de produits de réfrigération commerciale de pointe



16 Délégations



GRUPO 
Infrico®

 **Infrico**  **Impafri**  **Infrico**
Supermarket  **Infrico**
medcare  **bu**
YOU friBuffet



RESPONSABILITÉ

Sociale

CORPORATIVE



Notre équipe : notre plus grand atout

Chez Infrico, nous fabriquons des machines, mais ce qui compte le plus pour nous, ce sont les personnes. Le plus grand atout d'Infrico est son équipe et nous en prenons soin comme il se doit, car nous savons que la capacité productive de notre organisation dépend du bonheur de nos collaborateurs.

L'entreprise possède le certificat d'origine espagnole certifiée (O.E.C.) qui atteste que ses produits sont fabriqués en Espagne, devenant ainsi la première entreprise du secteur en Espagne à obtenir ce label après avoir réussi avec succès son processus d'audit exhaustif.

Ses centres de production sont situés à Lucena, dans la province de Cordoue, est l'une des installations industrielles les plus modernes d'Espagne. Trois usines d'une superficie totale de 160 000 mètres carrés pour la production, les activités logistiques et les bureaux.

Engagés pour la société :

Chez Infrico, nous voulons contribuer au progrès de la société et nous le faisons comme nous le savons le mieux, en appliquant les dernières technologies de R+D+i à la fabrication d'équipements de réfrigération industrielle qui offrent des solutions pour garantir le bien-être et veiller à la santé et la sécurité alimentaire. De plus, nous sommes conscients de notre responsabilité sociale en tant qu'agent économique et moteur du développement. Nous générons de la richesse en créant des emplois de qualité et nous collaborons également avec diverses causes sociales pour contribuer, avec notre soutien, à la création d'un environnement plus favorable pour ceux qui souffrent le plus.

Engagés dans l'innovation

Les bonnes idées sont la clé du succès. Infrico s'efforce constamment d'innover et d'améliorer ses équipements, un engagement qui a été certifié et reconnu par des distinctions et des prix internationaux. Pour cette raison, notre entreprise est la première entreprise du secteur à être accréditée par un système de gestion de la qualité basé sur la norme ISO 9001:2015, qui couvre toutes les machines de son catalogue.

Un engagement en faveur de l'environnement.

Dans notre travail quotidien, en plus de répondre aux besoins de nos clients, chez Infrico nous accordons une attention particulière aux initiatives qui contribuent au développement d'une industrie durable et respectueuse de l'environnement, par le biais d'une gestion correcte des ressources naturelles, de la mise en place d'un système de gestion de l'environnement, grâce à une gestion correcte des ressources naturelles, à un traitement approprié des déchets et au recyclage et à l'élimination des déchets.

Nous sommes très fiers d'avoir franchi avec succès les processus exhaustifs de des audits qui démontrent que notre engagement pour le maintien de l'environnement est une réalité approuvée par les experts de la défense et de la protection de notre planète.

Chez Infrico, nous sommes également pionniers dans la mise en œuvre du gaz R290, un réfrigérant vert qui ne pollue pas et minimise la consommation d'énergie électrique. Nous l'incorporons dans nos équipements et nous donnons des cours de formation sur les bonnes pratiques à suivre pour le manipuler.



Respect

DE L'ENVIRONNEMENT

Infrico, conformément à sa politique de respect et de conservation de l'environnement, est certifiée selon la norme environnementale internationale ISO 14001:2015. Nous veillons au respect de toutes les exigences légales et mettons en œuvre des politiques de réduction des ressources naturelles, de recyclage et de gestion des déchets. Nous sommes engagés dans l'éco-conception et la réduction de la consommation d'énergie. Nous utilisons des compresseurs économes en énergie et peu bruyants. Une isolation en polyuréthane injecté à haute pression, sans CFC, d'une densité de 40 kg/m³.

Nous respectons la directive RoHS [2011/95/EU], en vertu de laquelle "Nous déclarons que nos produits sont conformes, en ce qui concerne la restriction de l'utilisation de certaines substances dangereuses dans la fabrication de nos produits".

La restriction de l'utilisation de certaines substances dangereuses dans les équipements électriques et électroniques, telles que les substances chimiques comme le plomb, le mercure, le cadmium, le chrome hexavalent, les polybromobiphényles et les polybromodiphényléthers, et les polybromodiphényléthers à certaines concentrations".

CONDITIONS GÉNÉRALES DE Ventes

Garantie

Selon le CERTIFICAT DE GARANTIE qui accompagne chaque produit.

Commandes

Les demandes de commande doivent être adressées au siège d'Infrico, S.L. ou à nos délégations. Les commandes ne peuvent être annulées une fois que le matériel a été expédié. S'il s'agit d'une fabrication spéciale, aucune annulation ne sera acceptée une fois la fabrication lancée. Nous nous réservons le droit de ne pas traiter les commandes de clients qui n'ont pas respecté les contrats antérieurs. Les conditions particulières mentionnées dans la commande du client deviennent caduques si elles ne sont pas conformes aux présentes conditions générales de vente.

Frais de port

Dans le but de proposer les meilleurs prix à nos clients, nous prenons à notre charge les frais de transport lorsque les commandes sont supérieures à 2.500 € net HT.

Pour les commandes inférieures à 2.500 € net HT, on livre avec une participation aux frais de transport pris en charge par le professionnel, équivalent à 5% de la valeur nette de la commande.

Prise de RDV, pour faciliter les livraisons nos transporteurs vont contacter le professionnel et valident avec lui le rendez-vous selon les contraintes locales.

Déchargement des camions: il doit être assuré par le destinataire de la livraison. Le chauffeur n'est pas tenu de participer au déchargement

Emballage

Emballage Infrico standard inclus dans le prix.

Les prix

Les prix indiqués sont des prix de vente publics. Les taxes applicables seront facturées sur la facture correspondante. Les remises applicables aux articles optionnels seront équivalentes à la remise stipulée pour le catalogue des pièces détachées, à l'exception des tiroirs et des serrures lorsqu'ils sont incorporés à l'appareil.

Modalités de paiement

Les factures sont payées au comptant à notre siège social ou à nos délégations, sauf si un crédit est accordé au client. Dans ce cas, le paiement est effectué sous la forme et au lieu convenus.

Si, avant ou pendant l'exécution d'une commande, il se produit des circonstances susceptibles d'entraîner un défaut de paiement, le paiement doit être effectué dans la forme et le lieu convenus. Si, avant ou pendant l'exécution d'une commande, des circonstances surviennent qui pourraient conduire à un non-paiement, la livraison des marchandises peut être retardée tant que l'acheteur n'avance pas ou ne garantit pas le paiement de la somme due

Retours

Les retours de matériel ne sont pas acceptés, sauf autorisation d'Infrico. Dans tous les cas, le matériel doit être retourné franco de port et avec emballage.

Pièces détachées et accessoires

Aucun retour ne sera accepté, sauf autorisation du SAV.

Litiges

Dans ce cas, les tribunaux de Lucena [Cordoba] sont compétents.

Contrat



Fribuffet, la marque déposée d'Infrico est synonyme de design d'avant-garde, de technologie et qualité supérieure. Nous nous appuyons sur une longue expérience dans la fabrication de produits de réfrigération commerciale.

Entre autres parce que nous nous engageons à répondre aux demandes des clients les plus exigeants. En utilisant toujours les meilleurs matériaux et en respectant des contrôles de qualité internes stricts.

C'est ce qui nous permet d'offrir à nos clients les plus hautes normes de qualité.

L'équipe contractuelle et commerciale de Fribuffet, se distingue par son approche directe et ses solutions innovantes. En fournissant un service à la clientèle qui nous permet de comprendre leurs besoins et leurs désirs dès le début. De ce fait, l'une de nos caractéristiques est notre capacité d'adaptation aux besoins de nos clients.

Chez Fribuffet, nous combinons qualité, fonctionnalité et design. Tout cela pour que des professionnels tels que les architectes ou décorateurs d'intérieur nous fassent confiance pour leurs projets. Pour qu'ils sachent que nos produits, leurs idées et leurs designs sont le meilleur

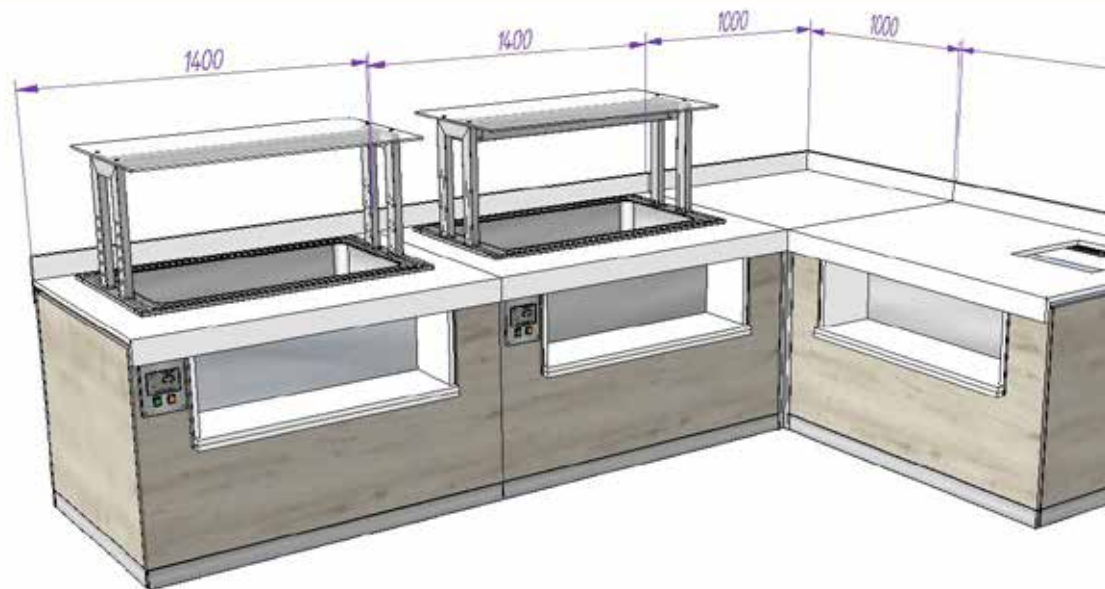

choix. La dernière génération et des designs de meubles adaptés nous permettent d'offrir un large éventail de possibilités, permettant aux designers, aux décorateurs et aux architectes de créer des ambiances et des espaces de vie avec un style unique et 100% fonctionnel.

Des designs uniques avec une longue durée de vie qui s'intègrent parfaitement dans tous les types d'environnements.

Pour cela, nous analyserons d'abord les possibilités offertes par l'espace afin d'offrir au client la meilleure alternative.

Gastrobuffet sur mesure



Nos Gastrobuffets sont conçus et peuvent adapter leurs modèles standard à tout espace et type d'hôtel ou de restaurant. Cela se fait de manière personnalisée en fonction des besoins de chaque client et après une étude de faisabilité, afin de s'assurer que l'installation est fonctionnelle, de haute qualité et qu'elle s'intègre à l'environnement décoratif.

Des options spéciales sont disponibles :

- **Option murale.**

En fonction de l'agencement et de la composition, s'il n'est pas possible de laisser 10 cm de séparation avec le mur, l'option murale peut être envisagée.

- **Panneau de commande en façade.**

Pour une meilleure accessibilité, le panneau de commande peut être placé sur la face avant de l'appareil.

- **Modèles sur mesure.**

- Configurer tout type de composition spéciale pour adapter les caractéristiques du buffet aux besoins de chaque client.

- Consulter pour toute autre considération particulière.

Exemples de projets

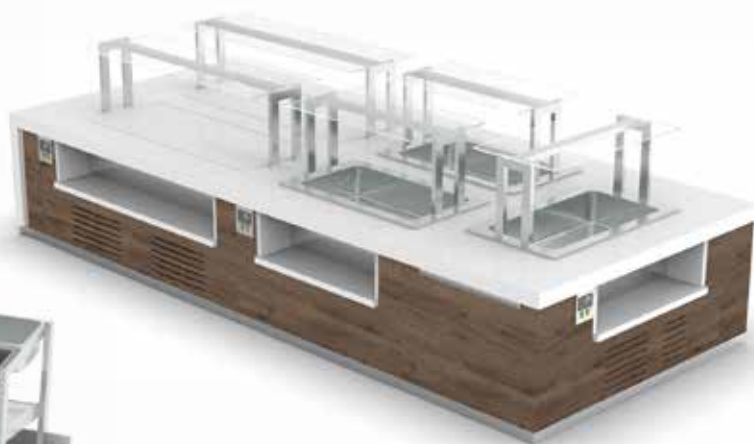
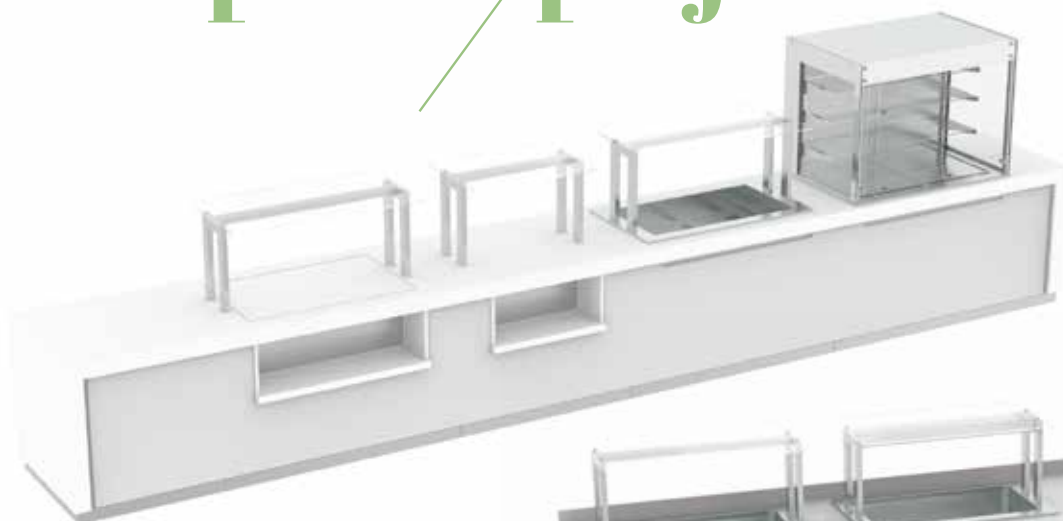



Basic Buffet





CARACTÉRISTIQUES GÉNÉRALES



STANDARD: Couleur blanche

OPTIONNEL:

- Gris

- ACIER INOXYDABLE AISI 304

- Les modules standard sont de couleur blanche, mais il est également possible d'avoir le corps en gris anthracite et en acier inoxydable. Les décorations sont disponibles en différentes couleurs et différentes finitions en bois, il y a aussi la possibilité de mettre des décorations plus longues.

- Roues standard pour le déplacement.

- Capacités disponibles en 2GN, 3GN et 4GN avec une grande variété d'installations.

- Possibilité de placer les plateaux des deux côtés du meuble et à des hauteurs différentes.

CONFIGURATION DU BASIC BUFFET

1. Sélectionner les modules [chaleur, froid ou neutre] et leur longueur [2GN, 3GN ou 4GN]

2. Indiquer la finition de la carrosserie et des décorations.

3. Sélectionnez les supports avec écran et les cristaux.



Exemple 1

- Modèle: MBUB4CF
- Corps standard
- Décoration bois Anniversaire 020AK
- Tablette inférieure
- Support d'écran: EEECU1 (1 hauteur)
- Verre supérieur: EEVSU1500
- Écrans: EEKIU1500 (éclairage)
- Traverse de plateau d'un côté



Exemple 2

- Modèle: MBUB4CF
- Corps gris anthracite
- Décoration bois Anniversaire 030AK
- Support d'écran: EEECU2 (2 hauteurs)
- Verre supérieur: EEVSU1500
- Verre avant: EEVFU1500
- Bibliothèque en cristal: EEVEU1500
- Écrans: EEKIU1500 (éclairage)
- Glissières de plateau des deux côtés



Exemple 3

- Modèle: MBUB4CF
- Corps en acier inoxydable
- Décoration en noir RAL 9017 et plus
- Support d'écran: EEECU1 (1 hauteur)
- Verre supérieur: EEVSU1500
- Afficheurs: EEPCU1500 (aveugle)

Série Basic Buffet Bain Marie Modèles



MBUB2BM



MBUB3BM

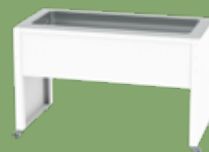

MBUB4BM



MODELE	PRIX	PRIX AVEC STRUCTURE	MESURES [mm]	TEMPERATURE [°C]	TENSION - FRÉQUENCE	RÉSERVOIR	PUISSANCE [W]
MBUB2BM			835 x 929 x 745 mm	+30°C/+90°C	230V/ 1ph/ 50Hz	2	1500
MBUB3BM			1155 x 929 x 745 mm	+30°C/+90°C	230V/ 1ph/ 50Hz	3	2500
MBUB4BM			1475 x 929 x 745 mm	+30°C/+90°C	400V/ 3ph/ 50Hz	4	3500

Série Basic Buffet Bain marie ventilé Modèles



MBUB3BMV



MBUB4BMV



MODELE	PRIX	PRIX AVEC STRUCTURE	MESURES [mm]	TEMPERATURE [°C]	CLASSE CLIMATIQUE [°C]	TENSION - FRÉQUENCE	MATÉRIAUX	RÉSERVOIR	PUISSANCE [W]
MBUB3BMV			1125 x 800 x 900 mm	+30°C/+90°C	4 / 38°C	230V/ 1ph/ 50Hz	AISI 304	3 GN	1040
MBUB4BMV			1500 x 800 x 900 mm	+30°C/+90°C	4 / 38°C	230V/ 1ph/ 50Hz	AISI 304	4 GN	2080



MBUB4BM ◀



MBUB3BMV ◀

Série Basic Buffet Vitrocéramique Modèles



MBUB2VC



MBUB3VC

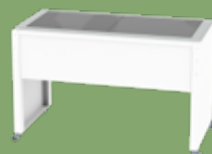

MBUB4VC



MODELE	PRIX	PRIX AVEC STRUCTURE	MESURES (mm)	TEMPERATURE (°C)	TENSION - FRÉQUENCE	RÉSERVOIR	PUISSANCE (W)
MBUB2VC			835 x 929 x 745 mm	Max +90°C	230V/ 1ph/ 50Hz	----	900
MBUB3VC			1155 x 929 x 745 mm	Max +90°C	230V/ 1ph/ 50Hz	----	1350
MBUB4VC			1475 x 929 x 745 mm	Max +90°C	230V/ 1ph/ 50Hz	----	1800



► MBUB4VC

Série Basic Buffet Cuve Froide Modèles



MBUB2CF



MBUB3CF



MBUB4CF

Série Basic Buffet Cuve Froide Ventilé Modèles



MBUB3CFV



MBUB4CFV

Série Basic Buffet Plaque Froide Modèles



MBUB2PF



MBUB3PF



MBUB4PF



► MBUB4CFV



► MBUB3PF



MODELE	PRIX	PRIX AVEC STRUCTURE	MESURES [mm]	TEMPERATURE [°C]	TENSION - FRÉQUENCE	RÉSERVOIR	PUISSANCE [W]
MBUB2CF			835 x 929 x 745 mm	+2°C/+10°C	230V/ 1ph/ 50Hz	2	223
MBUB3CF			1155 x 929 x 745 mm	+2°C/+10°C	230V/ 1ph/ 50Hz	3	223
MBUB4CF			1475 x 929 x 745 mm	+2°C/+10°C	230V/ 1ph/ 50Hz	4	223



MODELE	PRIX	PRIX AVEC STRUCTURE	MESURES [mm]	TEMPERATURE [°C]	TENSION - FRÉQUENCE	RÉSERVOIR	PUISSANCE [W]
MBUB3CFV			1155 x 929 x 745 mm	+2°C/+10°C	230V/ 1ph/ 50Hz	3	637
MBUB4CFV			1475 x 929 x 745 mm	+2°C/+10°C	230V/ 1ph/ 50Hz	4	637



MODELE	PRIX	PRIX AVEC STRUCTURE	MESURES [mm]	TEMPERATURE [°C]	TENSION - FRÉQUENCE	RÉSERVOIR	PUISSANCE [W]
MBUB2PF			835 x 929 x 745 mm	-4°C/+4°C	230V/ 1ph/ 50Hz	---	223
MBUB3PF			1155 x 929 x 745 mm	-4°C/+4°C	230V/ 1ph/ 50Hz	---	223
MBUB4PF			1475 x 929 x 745 mm	-4°C/+4°C	230V/ 1ph/ 50Hz	---	223



► MBUB4CF

Vitrine Basic Buffet Ouverte Surbaissée Modèles



MBUB3VAB



MBUB4VAB

Vitrine Basic Buffet Avec Rideau de Nuit Intégré Modèles



MBUB3VMC



MBUB4VMC

Série Basic Buffet Avec Verre de Façade de Vitrine Modèles



MBUB3VAV



MBUB4VAV

MBUB4VAB ◀





MODELE	PRIX	MESURES [mm]	TEMPERATURE [°C]	TENSION - FRÉQUENCE	PUISSANCE [W]
MBUB3VAB		1155 x 1111 x 745 mm	-4°C/+12°C	230V/ 1ph/ 50Hz	437
MBUB4VAB		1475 x 1111 x 745 mm	-4°C/+12°C	230V/ 1ph/ 50Hz	437



MODELE	PRIX	MESURES [mm]	TEMPERATURE [°C]	TENSION - FRÉQUENCE	PUISSANCE [W]
MBUB3VMC		1155 x 1546 x 745 mm	-4°C/+12°C	230V/ 1ph/ 50Hz	1246
MBUB4VMC		1475 x 1546 x 745 mm	-4°C/+12°C	230V/ 1ph/ 50Hz	1646



MODELE	PRIX	MESURES [mm]	TEMPERATURE [°C]	TENSION - FRÉQUENCE	PUISSANCE [W]
MBUB3VAV		1155 x 1546 x 745 mm	-4°C/+12°C	230V/ 1ph/ 50Hz	804
MBUB4VAV		1475 x 1546 x 745 mm	-4°C/+12°C	230V/ 1ph/ 50Hz	1000



MBUB4VAV ◀

Série Basic Buffet Neutre Modèles



MBUB2NE



MBUB3NE

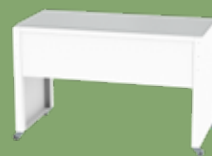

MBUB4NE



MBUBESQ

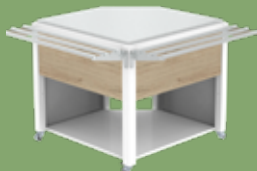

MODELE	PRIX	PRIX AVEC STRUCTURE	MESURES [mm]	TEMPERATURE [°C]	TENSION - FRÉQUENCE	RÉSERVOIR	PUISSANCE [W]
MBUB2NE			835 x 929 x 745 mm	---	230V/ 1ph/ 50Hz*	---	---
MBUB3NE			1155 x 929 x 745 mm	---	230V/ 1ph/ 50Hz*	---	---
MBUB4NE			1475 x 929 x 745 mm	---	230V/ 1ph/ 50Hz*	---	---
MBUBESQ	A Consulter	A Consulter	1060 x 929 x 1060	---	---	---	---

* Si lleva iluminación y/o infrarrojo.

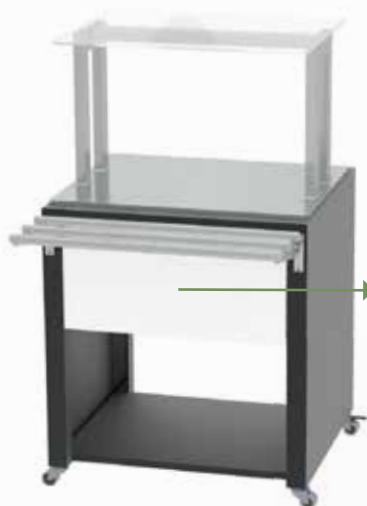

MBUB2NE

Décoration Standard



MBUBESQ



MBUB4NE

Décoration Frontale optionnelle

CHASSIS

Couleurs basic buffet

Vous pouvez choisir entre 2 couleurs de châssis (blanc et gris anthracite).
Châssis en inox (consulter).



BLANC



ACIER



GRIS ANTHRACITE

Glissière de plateau à charnière

Nouvelle glissière pour plateau à haut design technologique



GLISSIÈRE DE PLATEAU À CHARNIÈRE

MODÈLES	CBBU2	CBBU3	CBBU4
PRIX			
MESURE [mm]	820 x317x145	1140 x317x145	1460 x317x145

Etagère inférieure

Il est possible de sélectionner l'élément inférieur de la même couleur que la structure.



ETAGÈRE INFÉRIEUR

MODÈLES	ESTBU2	ESTBU3	ESTBU4
PRIX			
MESURE [mm]	799x618x24	1119x618x24	1439x618x24

Augmentation de Prix pour changement de décoration



AUGMENTATION DU PVP POUR LA DÉCORATION EN PROFONDEUR			
MODÈLES	2GN	3GN	4GN
PRIX			
MESURE [mm]	707x828x19	1027x828x19	1347x828x19

Seule une décoration courte ou moyenne peut être modifiée, comme le montrent les images suivantes.

Décoration courte



Décoration longue



Décoration Moyenne



Décoration Longue



Couleur de la Décoration



ANNIVERSARY 010AK



RAL 9016 Blanc



RAL 9017 Noir



Wengé



Nogal



Aubergine



RAL 4007 Violet



RAL 3003 Marron



RAL 3020 Rouge



Curry Curry



RAL 1001 Beige



RAL 6002 Vert Foncé



RAL 1107060 Pistache



RAL 5015 Bleu



RAL 2108025 Bleu Ciel



Cuzco Cuivre



Gris Métal



IDA03RT



ANNIVERSAIRE 010AK



ANNIVERSAIRE 020AK



ANNIVERSAIRE 030AK

Autre couleur consulter le prix

Il peut y avoir une variation entre la couleur de l'impression et la couleur réelle

Jeux d'écrans de Composition

En fonction des besoins, il est possible de procéder aux combinaisons suivantes pour composer un ensemble complet:



(A)

- A.**
***Support à hauteur unique**
 - Support à hauteur unique : EEECU1
 - Écran: EEPCU
 - Plateau en verre : EEVSU



(B)

- B.**
***Support à une hauteur**
 - Support à hauteur unique: EEECU1
 - Écran [éclairage+ infrarouge]
 - Plateau en verre: EEVSU
 - Verre avant: EEVFU



(C)

- C.**
*** Support à double hauteur**
 - Support à double hauteur: EEECU2
 - Écran [2 unités] [éclairage + infrarouge]
 - Plateau en verre: EEVSU
 - Tablette en verre : EEVEU



(D)

- D.**
*** Double hauteur et verre frontal**
 - Support double hauteur: EEECU2
 - Écran [2 unités] [éclairage et Infrarouge]
 - Verre supérieur: EEVSU
 - Tablette en verre: EEVEU
 - Verre avant: EEVFU

Supports d'écran



MODÈLES	EEECU1	EEECU2
PRIX		
HAUTEUR (mm)	1	2
MESURES (mm)	260x30x476	260x30x766

Type d'écrans

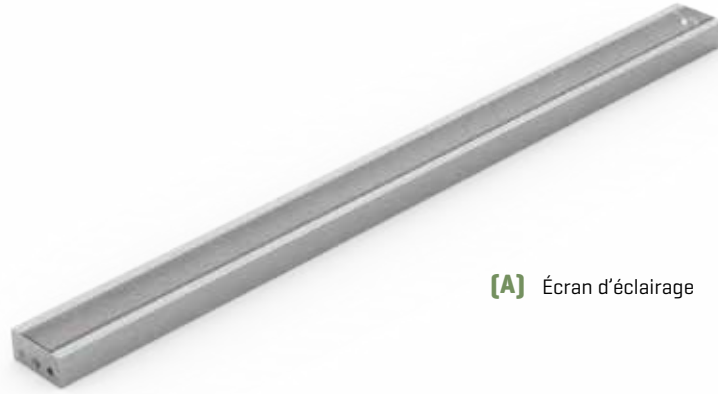

(A) Écran d'éclairage

	(A) Écran D'éclairage		
MODÈLES	EEPCU750	EEPCU1125	EEPCU1500
PRIX			
MESURES [mm]	710x74x36	1030x74x36	1350x74x36
Pour les modules de:	2GN	3GN	4GN

	(A) Écran D'éclairage		
MODÈLES	EEKIU750	EEKIU1125	EEKIU1500
PRIX			
MESURES [mm]	710x74x36	1030x74x36	1350x74x36
Pour les modules de:	2GN	3GN	4GN



(B) Écran infrarouge

	(B) Écran Infrarouge		
MODÈLES	EEKIRU750	EEKIRU1125	EEKIRU1500
PRIX			
MESURES [mm]	710x155x74	1030x155x74	1350x155x74
PUISSANCE	500 W	1000 W	1500 W
Para Módulos de: For Modules of:	2GN	3GN	4GN



[C] Eclairage et écran infrarouge

	[C] Éclairage Et Écran Infrarouge		
MODÈLES	EEKIRLU750	EEKIRLU1125	EEKIRLU1500
PRIX			
MESURES (mm)	710x248x74	1030x248x74	1350x248x74
PUISSANCE	500 W	1000 W	1500 W
Pour les modules de:	2GN	3GN	4GN

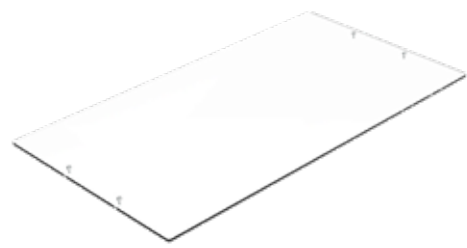

[D] Vitre Supérieure

	[D] Vitre Supérieure		
MODÈLES	EEVSU750	EEVSU1125	EEVSU1500
PRIX			
MESURES (mm)	790x590x8	1110x590x8	1430x590x8
Pour les modules de:	2GN	3GN	4GN



[E] Étagère en Verre

	[E] Étagère en Verre		
MODÈLES	EEVEU750	EEVEU1125	EEVEU1500
PRIX			
MESURES (mm)	705x470x8	1025x470x8	1345x470x8
Pour les modules de:	2GN	3GN	4GN



[F] Vitre Frontale

	[F] Vitre Frontale		
MODÈLES	EEVFU750	EEVFU1125	EEVFU1500
PRIX			
MESURES (mm)	790x460x8	1110x460x8	1430x460x8
Pour les modules de:	2GN	3GN	4GN

2

Gastro Buffet





CARACTÉRISTIQUES GÉNÉRALES



- Modules standard avec comptoir et décorations en blanc.
- Décoration disponible en plusieurs couleurs et plusieurs finitions de bois.
- Comptoirs en quartz avec façade de 90 mm. Disponible dans d'autres couleurs.
- Roues standard pour le déplacement.
- Pieds réglables en hauteur pour fixer et stabiliser la position du meuble.
- Des modules autonomes ou des configurations linéaires peuvent être fournis.
- Kit d'assemblage pour la fourniture d'un linéaire de plusieurs modules.
- Côtés et plinthes amovibles pour faciliter l'accès à l'intérieur du meuble.
- Capacités disponibles en 2GN, 3GN, 4GN et 5GN avec une grande variété d'entrées.
- Les fonds disponibles sont de 830 mm et 1000 mm.
- Tiroir à assiettes éclairé disponible sur fond de 1000mm, sauf dans les réservoirs froids ventilés et dans les vitrines. En fond 830mm uniquement disponible en plaques froides, vitrocéramiques et neutres.
- Composition écran d'éclairage avec support de 1 hauteur et store screen inclus, sauf dans les modules neutres.
- Affichages disponibles : illumination, infrarouge et illumination plus infrarouge.
- L'encastrement est centré dans le module inférieur de 830 mm et déplacé vers le bas dans le module de 1000 mm, laissant ainsi à l'avant un espace disponible de 252 mm qui permet la fonction de glissières de plateau.

PROFONDEUR DU MODULE 830 mm



PROFONDEUR DU MODULE 1000 mm



CONFIGURATION LINÉAIRE BUFFET

1. Choisissez la profondeur souhaitée : Profondeur 830mm ou 1000mm.
2. Sélectionner les modules (chaleur, froid ou neutre)
3. Choisissez la longueur [2GN, 3GN, 4GN ou 5GN]
4. Indiquez la couleur du plan de travail et des décorations.
5. Sélectionnez les supports avec écran et les cristaux



EXEMPLE DE BUFFET LINÉAIRE

Les lignes sont configurées de l'extérieur vers l'intérieur et les modules sont configurés de manière indépendante.
Les modules linéaires sont configurés de gauche à droite et les modules sont configurés indépendamment

1. MB100TL30

- Plan de travail : noir
- Décorations : Anniversaire 030AK

2. MB100NE3

- Plan de travail : noir
- Décorations : Anniversaire 030AK
- Support d'écran : EEECU2 [2 hauteurs]
- Écrans : EEPCU1125 [standard], EEKIU1125 [éclairage]
- Dessus en verre : EEVSU1125
- Tablette en verre : EEVEU1125
- Vitre avant : EEVFU1125

3. MB100BM3

- Plan de travail : noir
- Décorations : Anniversaire 030AK
- Support d'écran : EEECU1 [1 hauteur]
- Écrans : EEKIRU1125 [infrarouge]
- Dessus en verre : EEVSU1125
- Vitre avant : EEVFU1125

4. MB100PF3

- Plan de travail : noir
- Décorations : Anniversaire 030AK
- Support d'écran : EEECU1 [1 hauteur]
- Écran : EEKIU1125 [éclairage]
- Vitre avant : EEVSU1125

5. MB100VAV3

- Plan de travail : noir
- Décorations : Anniversaire 030AK

6. MB100TL100

- Plan de travail : noir
- Décorations : Anniversaire 030AK

Série Gastrobuffet Bain Marie Modèles

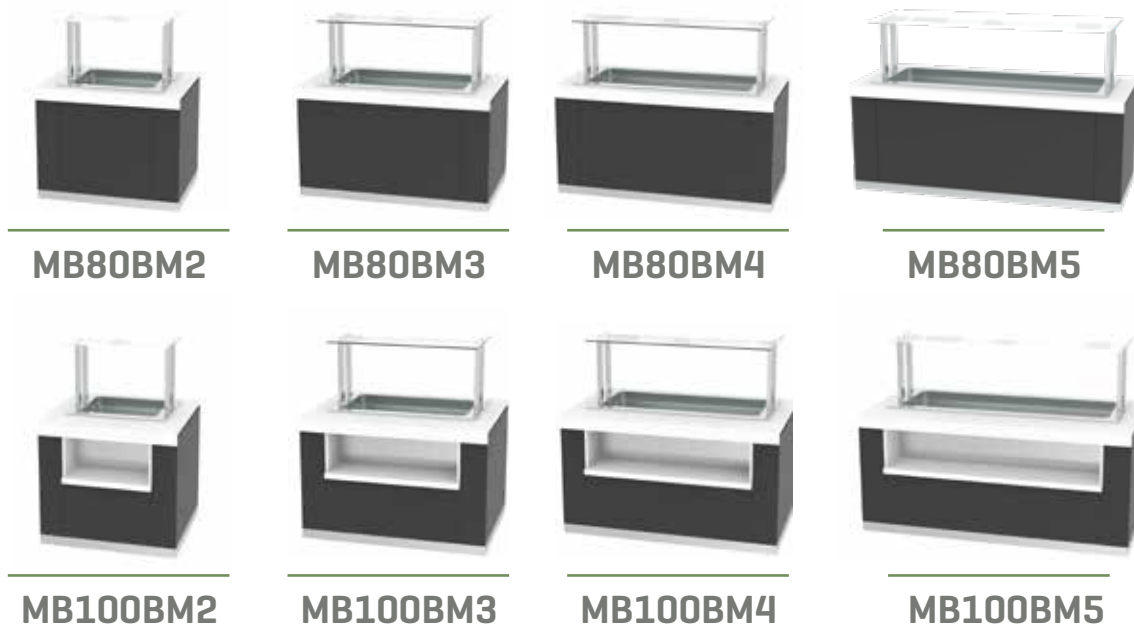

Éléments d'éclairage optionnels

Éclairage LED de série





MODELE	PRIX	MESURES [mm]	TEMPERATURE [°C]	DONNÉES ÉLECTRIQUES	SUPPORT D'ASSIETTES	RÉSERVOIR	PUISSANCE [W]
MB80BM2		1100 x 830 x 900 mm	+30°C/+90°C	230V/ 1ph/ 50Hz	----	2	1500
MB80BM3		1400 x 830 x 900 mm	+30°C/+90°C	230V/ 1ph/ 50Hz	----	3	2500
MB80BM4		1700 x 830 x 900 mm	+30°C/+90°C	400V/ 3ph/ 50Hz	----	4	3500
MB80BM5		2025 x 830 x 900 mm	+30°C/+90°C	400V/ 3ph/ 50Hz	----	5	4500
MB100BM2		1100 x 1000 x 900 mm	+30°C/+90°C	230V/ 1ph/ 50Hz	1	2	1500
MB100BM3		1400 x 1000 x 900 mm	+30°C/+90°C	230V/ 1ph/ 50Hz	1	3	2500
MB100BM4		1700 x 1000 x 900 mm	+30°C/+90°C	400V/ 3ph/ 50Hz	1	4	3500
MB100BM5		2025 x 1000 x 900 mm	+30°C/+90°C	400V/ 3ph/ 50Hz	1	5	4500

Haut de gamme blanc. Pour modifier le prix du plateau, il faut augmenter le prix [A consulter].



MB80BM4 ◀

Séries Gastrobuffet Bain Marie Ventilé Modèles



MB80BMV3

Bain Marie ventilé



MB80BMV4

Bain Marie ventilé



MB100BMV3

Bain Marie ventilé



MB100BMV4

Bain Marie ventilé





MODELE	PRIX	MESURES (mm)	TEMPERATURE (°C)	DONNÉES ÉLECTRIQUES	RÉSERVOIR	SUPPORT D'ASSIETTES	PUISSANCE (W)	POTENCIA FRIG. CAPACITÉ DE REFROIDISSEMENT (W A -10°C)
MB80BMV3		1400 x 830 x 900 mm	+30°C/+90°C	230V / 1ph / 50Hz	3	----	1040	----
MB80BMV4		1700 x 830 x 900 mm	+30°C/+90°C	230V / 1ph / 50Hz	4	----	2080	----
MB100BMV3		1400 x 1000 x 900 mm	+30°C/+90°C	230V / 1ph / 50Hz	3	1	1040	----
MB100BMV4		1700 x 1000 x 900 mm	+30°C/+90°C	230V / 1ph / 50Hz	4	1	2080	----

Haut de gamme blanc. Pour modifier le prix du plateau, il faut augmenter le prix [A consulter].



Série Gastrobuffet Vitrocéramique Modèles



MB80VC3



MB80VC4



MB100VC3



MB100VC4





MODELE	PRIX	MESURES (mm)	TEMPERATURE (°C)	DONNÉES ÉLECTRIQUES	SUPPORT D'ASSIETTES	PUISSANCE (W)
MB80VC3		1400 x 830 x 900 mm	Max. +130°C	230V/ 1ph/ 50Hz	1	1369
MB80VC4		1700 x 830 x 900 mm	Max. +130°C	230V/ 1ph/ 50Hz	1	1825
MB100VC3		1400 x 1000 x 900 mm	Max. +130°C	230V/ 1ph/ 50Hz	1	1369
MB100VC4		1700 x 1000 x 900 mm	Max. +130°C	230V/ 1ph/ 50Hz	1	1825

Haut de gamme blanc. Pour modifier le prix du plateau, il faut augmenter le prix [A consulter].



MB100VC3 ◀
Vue arrière

Série Gastrobuffet Réservoir Froid Modèles

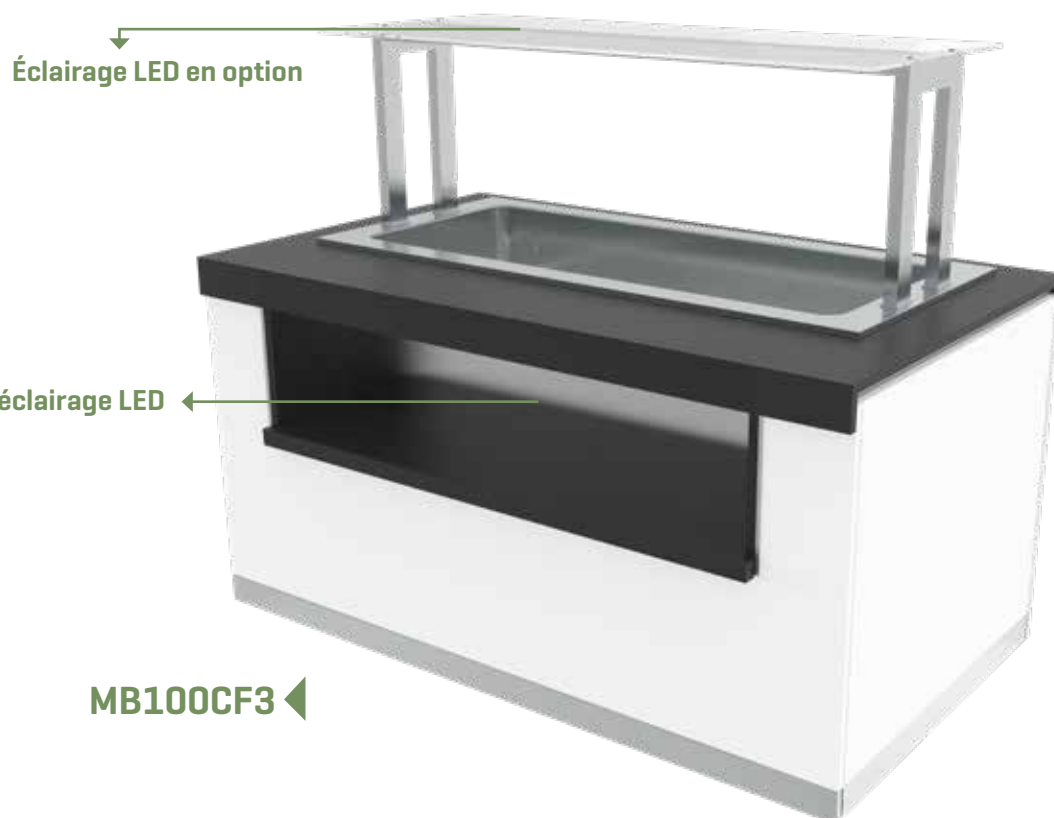



MODELE	PRIX	MESURES (mm)	TEMPERATURE (°C)	DONNÉES ÉLECTRIQUES	SUPPORT D'ASSIETTES	RÉSERVOIR	PUISSANCE (W)	POTENCIA FRIG. CAPACITÉ DE REFRIGERATION (W A -10°C)
MB80CF2		1100 x 830 x 900 mm	+2°C/+10°C	230V/ 1ph/ 50Hz	----	2	230	370
MB80CF3		1400 x 830 x 900 mm	+2°C/+10°C	230V / 1ph / 50Hz	----	3	233	370
MB80CF4		1700 x 830 x 900 mm	+2°C/+10°C	230V / 1ph / 50Hz	----	4	236	370
MB80CF5		2025 x 830 x 900 mm	+2°C/+10°C	230V / 1ph / 50Hz	----	5	396	687
MB100CF2		1100 x 1000 x 900 mm	+2°C/+10°C	230V / 1ph / 50Hz	1	2	230	370
MB100CF3		1400 x 1000 x 900 mm	+2°C/+10°C	230V / 1ph / 50Hz	1	3	233	370
MB100CF4		1700 x 1000 x 900 mm	+2°C/+10°C	230V / 1ph / 50Hz	1	4	236	370
MB100CF5		2025 x 1000 x 900 mm	+2°C/+10°C	230V / 1ph / 50Hz	1	5	396	687
MB80CH4		1100 x 830 x 900 mm	-12°C/-18°C	230V / 1ph / 50Hz	----	4	322	306
MB100CH4		1100 x 1000 x 900 mm	-12°C/-18°C	230V / 1ph / 50Hz	1	4	322	306

REFRIGERANT R290

Haut de gamme blanc. Pour modifier le prix du plateau, il faut augmenter le prix [A consulter].



Serie Gastrobuffet Cuve Froid Ventilé Modele



MB80CFV3



MB80CFV4



MB100CFV3



MB100CFV4





MODELE	PRIX	MESURES (mm)	TEMPERATURE (°C)	DONNÉES ÉLECTRIQUES	RÉSERVOIR	SUPPORT D'ASSIETTES	PUISSANCE (W)	POTENCIA FRIG. CAPACITÉ DE REFROIDISSEMENT (W A -10°C)
MB80CFV3		1400 x 830 x 900 mm	+2°C/+10°C	230V/ 1ph/ 50Hz	3	-----	897	687
MB80CFV4		1700 x 830 x 900 mm	+2°C/+10°C	230V / 1ph / 50Hz	4	-----	900	687
MB100CFV3		1400 x 1000 x 900 mm	+2°C/+10°C	230V / 1ph / 50Hz	3	-----	897	687
MB100CFV4		1700 x 1000 x 900 mm	+2°C/+10°C	230V / 1ph / 50Hz	4	-----	900	687

CUIVE FROIDE: REFRIGERANT R290

Haut de gamme blanc. Pour modifier le prix du plateau, il faut augmenter le prix [A consulter].



MB100CFV4 ◀

Série Gastrobuffet Plaque Froide Modèles



MB80PF3



MB80PF4



MB80PF5



MB100PF3



MB100PF4

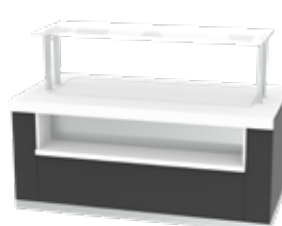

MB100PF5

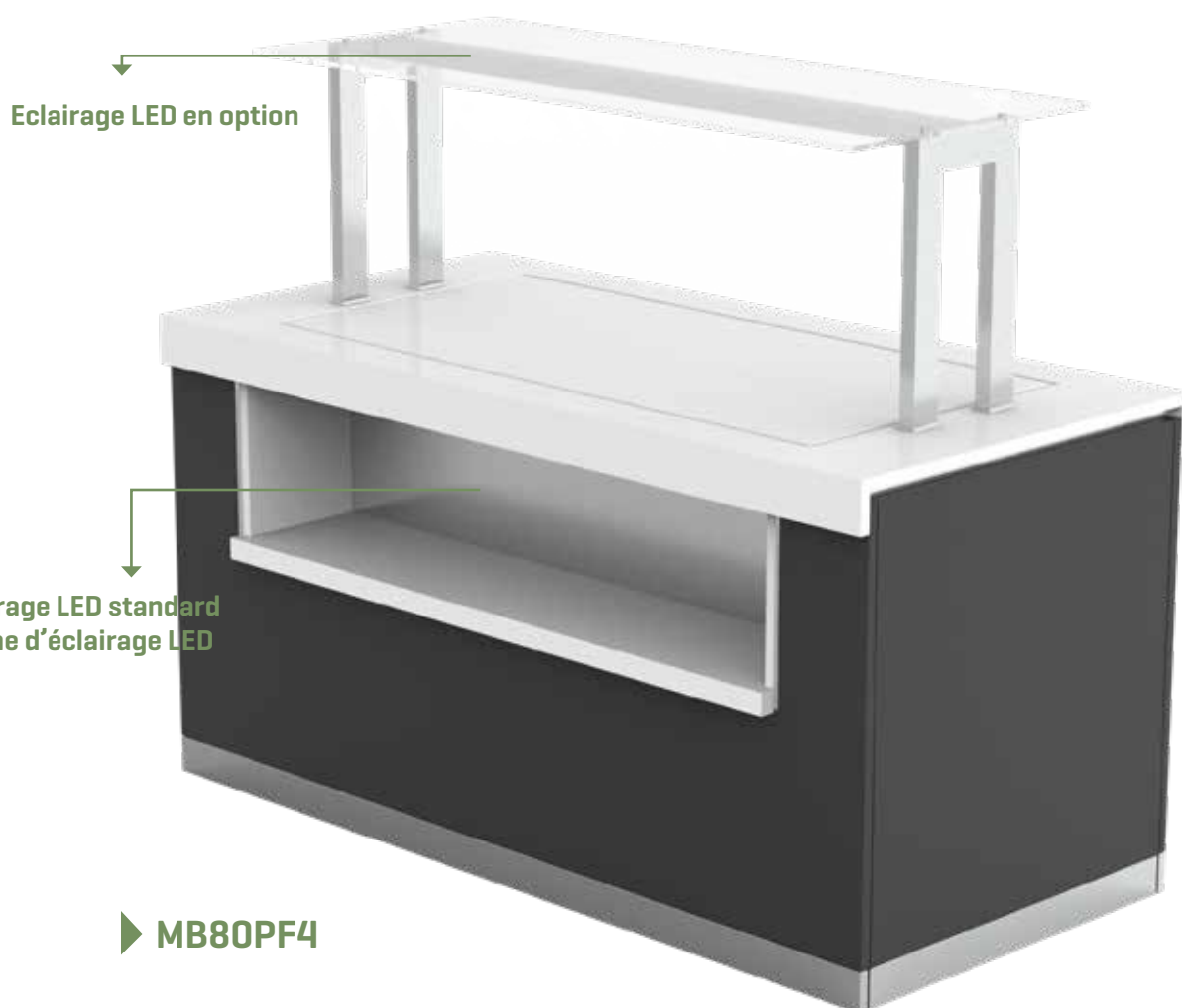



MODELE	PRIX	MESURES [mm]	TEMPERATURE [°C]	DONNÉES ÉLECTRIQUES	SUPPORT D'ASSIETTES	PUISSANCE [W]	POTENCIA FRIG. CAPACITÉ DE REFRIGIEM ENT [W A -10°C]
MB80PF3		1400 x 830 x 900 mm	-4°C/+4°C	230V/ 1ph/ 50Hz	1	187	370
MB80PF4		1700 x 830 x 900 mm	-4°C/+4°C	230V / 1ph / 50Hz	1	190	370
MB80PF5		2025 x 830 x 900 mm	-4°C/+4°C	230V / 1ph / 50Hz	1	350	687
MB100PF3		1400 x 1000 x 900 mm	-4°C/+4°C	230V / 1ph / 50Hz	1	187	370
MB100PF4		1700 x 1000 x 900 mm	-4°C/+4°C	230V / 1ph / 50Hz	1	190	370
MB100PF5		2025 x 1000 x 900 mm	-4°C/+4°C	230V / 1ph / 50Hz	1	350	687

REFRIGERANT R290

Haut standard blanc. Pour modifier le prix du plateau, il faut augmenter le prix [A consulter].



Série Vitrine Ouverte Basse Modèles



MB80VAB3



MB80VAB4



MB100VAB3



MB100VAB4

Éclairage LED de série
Norme d'éclairage LED



▶ MB100VAB4



MODELE	PRIX	MESURES (mm)	TEMPERATURE (°C)	DONNÉES ÉLECTRIQUES	RÉSERVOIR	SUPPORT D'ASSIETTES	PUISSANCE (W)	POTENCIA FRIG. CAPACITÉ DE REFROIDISSEMENT (W A -10°C)
MB80VAB3		1400 x 830 x 1200 mm	+2°C/+10°C	230V/ 1ph/ 50Hz	3	----	417	687
MB80VAB4		1700 x 830 x 1200 mm	+2°C/+10°C	230V / 1ph / 50Hz	4	----	512	687
MB100VAB3		1400 x 1000 x 1200 mm	+2°C/+10°C	230V / 1ph / 50Hz	3	----	417	687
MB100VAB4		1700 x 1000 x 1200 mm	+2°C/+10°C	230V / 1ph / 50Hz	4	----	512	687

REFRIGERANT R290

Haut standard blanc. Pour modifier le prix du plateau, il faut augmenter le prix [A consulter].



Éclairage LED Standard
Norme d'éclairage LED

► **MB80VAB3**
Vue de l'arrière

Serie Vitrinas Gastrobuffet Avec Rideaux Models



MB80VMC3



MB80VMC4



MB100VMC3



MB100VMC4

Éclairage LED Standard
Norme d'éclairage LED



MB100VMC3 ◀



MODELE	PRIX	MESURES (mm)	TEMPERATURE (°C)	DONNÉES ÉLECTRIQUES	RÉSERVOIR	SUPPORT D'ASSIETTES	PUISSANCE (W)	POTENCIA FRIG. CAPACITÉ DE REFROIDISSEMENT (W A -10°C)
MB80VMC3		1400 x 830 x 1750 mm	+4°C/+12°C	230V/ 1ph/ 50Hz	3	----	1246	1296
MB80VMC4		1700 x 830 x 1750 mm	+4°C/+12°C	230V / 1ph / 50Hz	4	----	1646	1805
MB100VMC3		1400 x 1000 x 1750 mm	+4°C/+12°C	230V / 1ph / 50Hz	3	----	1246	1296
MB100VMC4		1700 x 1000 x 1750 mm	+4°C/+12°C	230V / 1ph / 50Hz	4	----	1646	1805

REFRIGERANT R290

Haut standard blanc. Pour modifier le prix du plateau, il faut augmenter le prix [A consulter].

Éclairage LED Standard
Norme d'éclairage LED

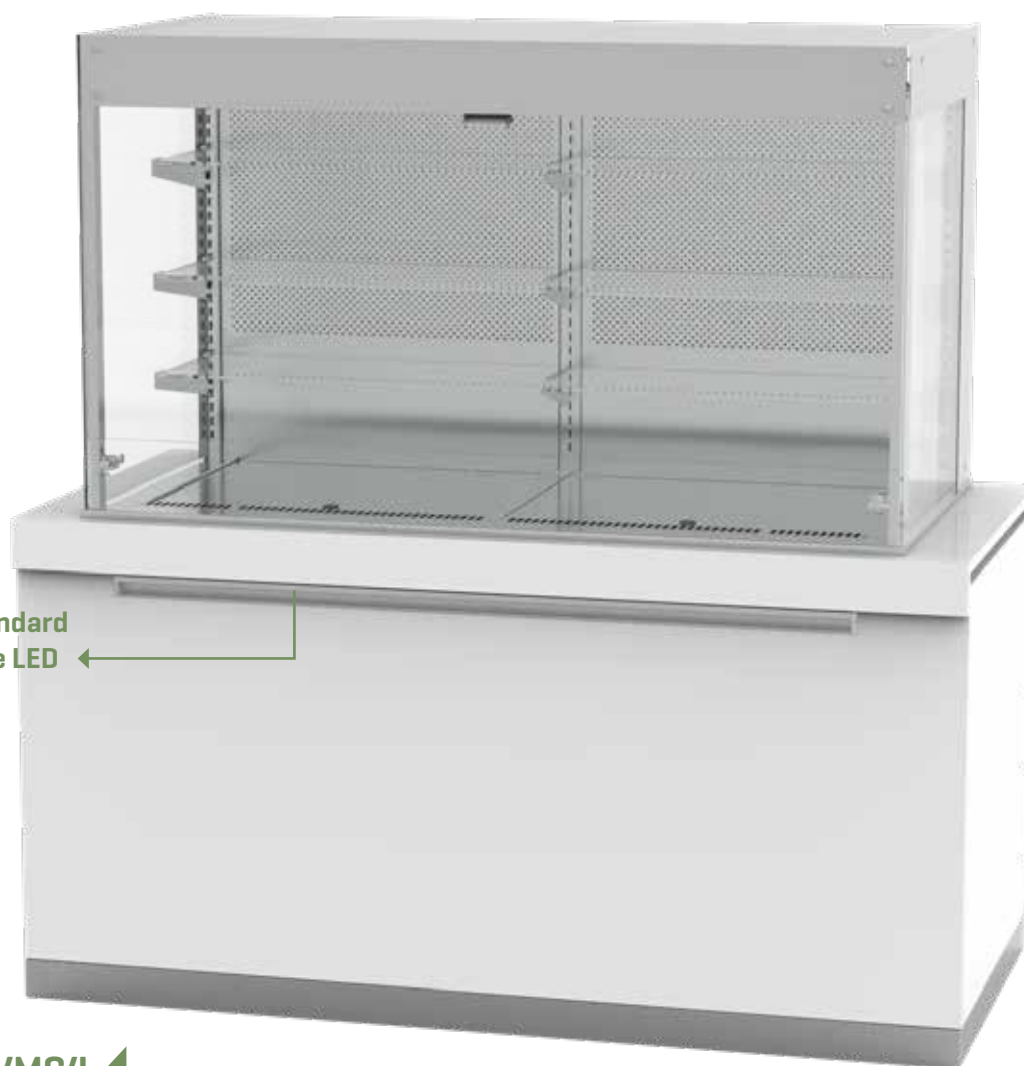

MB80VMC4 ◀

Série Vitrine Gastrobuffet Avec Verre Frontal Rabattable Modèles



MB80VAV3

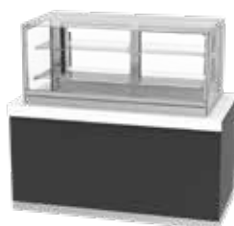

MB80VAV4



MB100VAV3



MB100VAV4

Éclairage LED Standard
Norme d'éclairage LED



MB80VAV3 ◀



MODELE	PRIX	MESURES [mm]	TEMPERATURE [°C]	DONNÉES ÉLECTRIQUES	RÉSERVOIR	SUPPORT D'ASSIETTES	PUISSANCE [W]	POTENCIA FRIG. CAPACITÉ DE REFROIDISSEMENT [W A -10°C]
MB80VAV3		1400 x 830 x 1428 mm	+4°C/+12°C	230V / 1ph / 50Hz	3	----	804	951
MB80VAV4		1700 x 830 x 1428 mm	+4°C/+12°C	230V / 1ph / 50Hz	4	----	1000	1296
MB100VAV3		1400 x 1000 x 1428 mm	+4°C/+12°C	230V / 1ph / 50Hz	3	----	804	951
MB100VAV4		1700 x 1000 x 1428 mm	+4°C/+12°C	230V / 1ph / 50Hz	4	----	1000	1296

REFRIGERANT R290

Haut de gamme blanche. Pour modifier le prix du plateau, il faut augmenter le prix [A consulter].

Éclairage LED de série
Norme d'éclairage LED



MB100VAV4 ◀

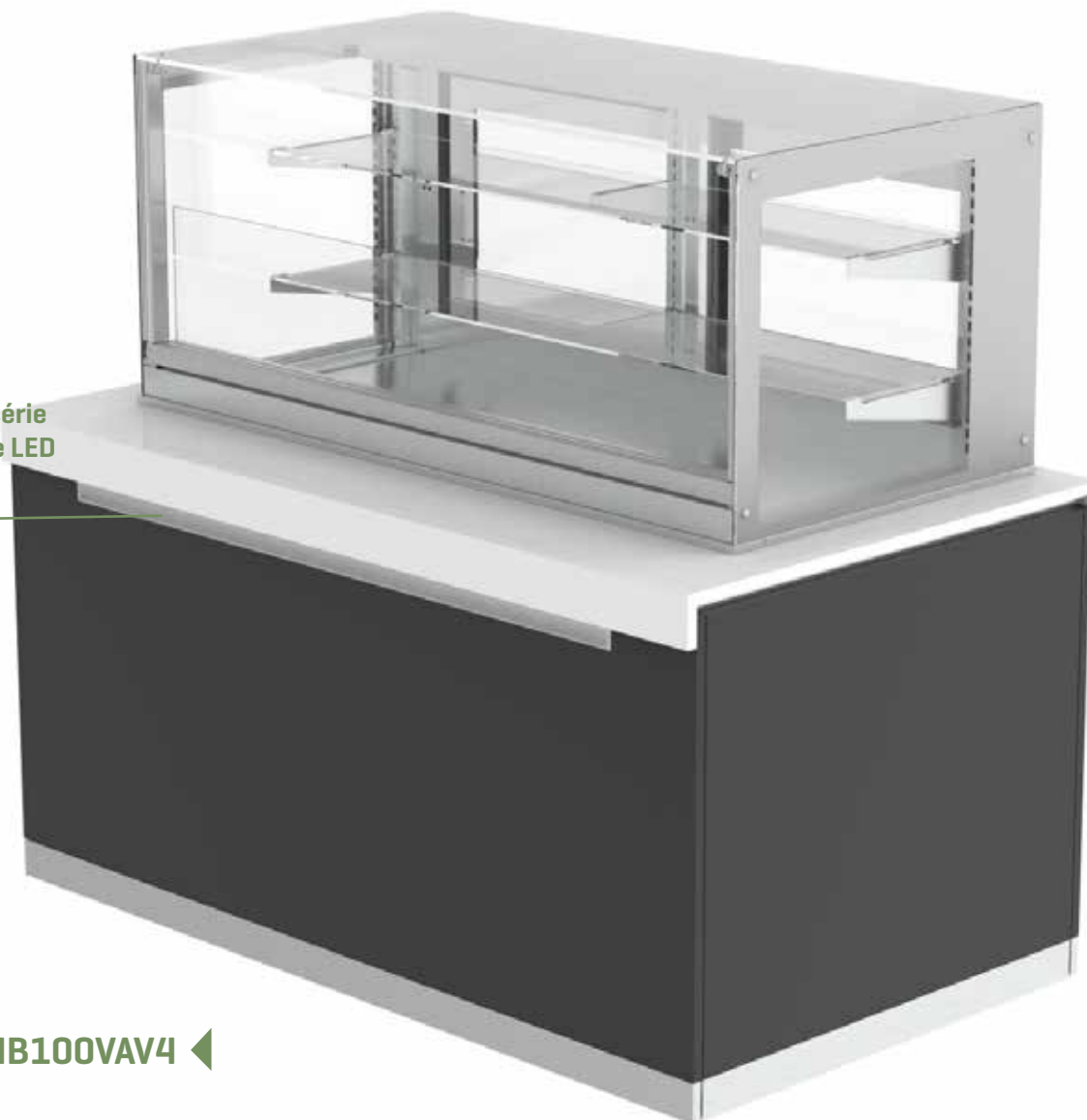

Série Gastrobuffet Neutre Modèles

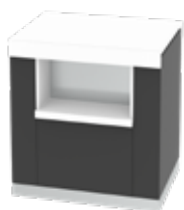

MB80NE2
1100 x 830 x 900 mm

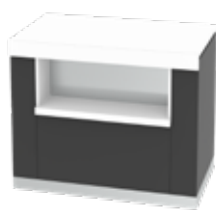

MB80NE3
1400 x 830 x 900 mm

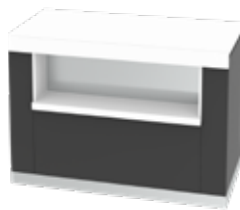

MB80NE4
1700 x 830 x 900 mm

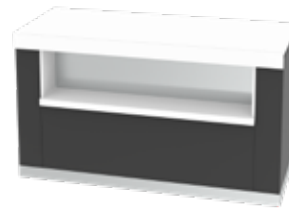

MB80NE5
2025 x 830 x 900 mm

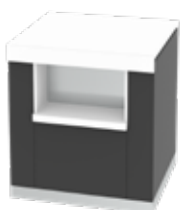

MB100NE2
1100 x 1000 x 900 mm

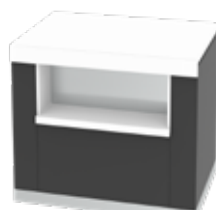

MB100NE3
1400 x 1000 x 900 mm

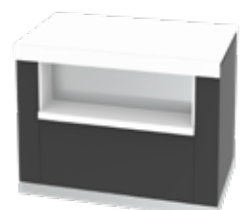

MB100NE4
1700 x 1000 x 900 mm

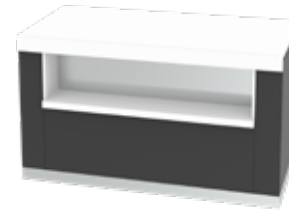

MB100NE5
2025 x 1000 x 900 mm

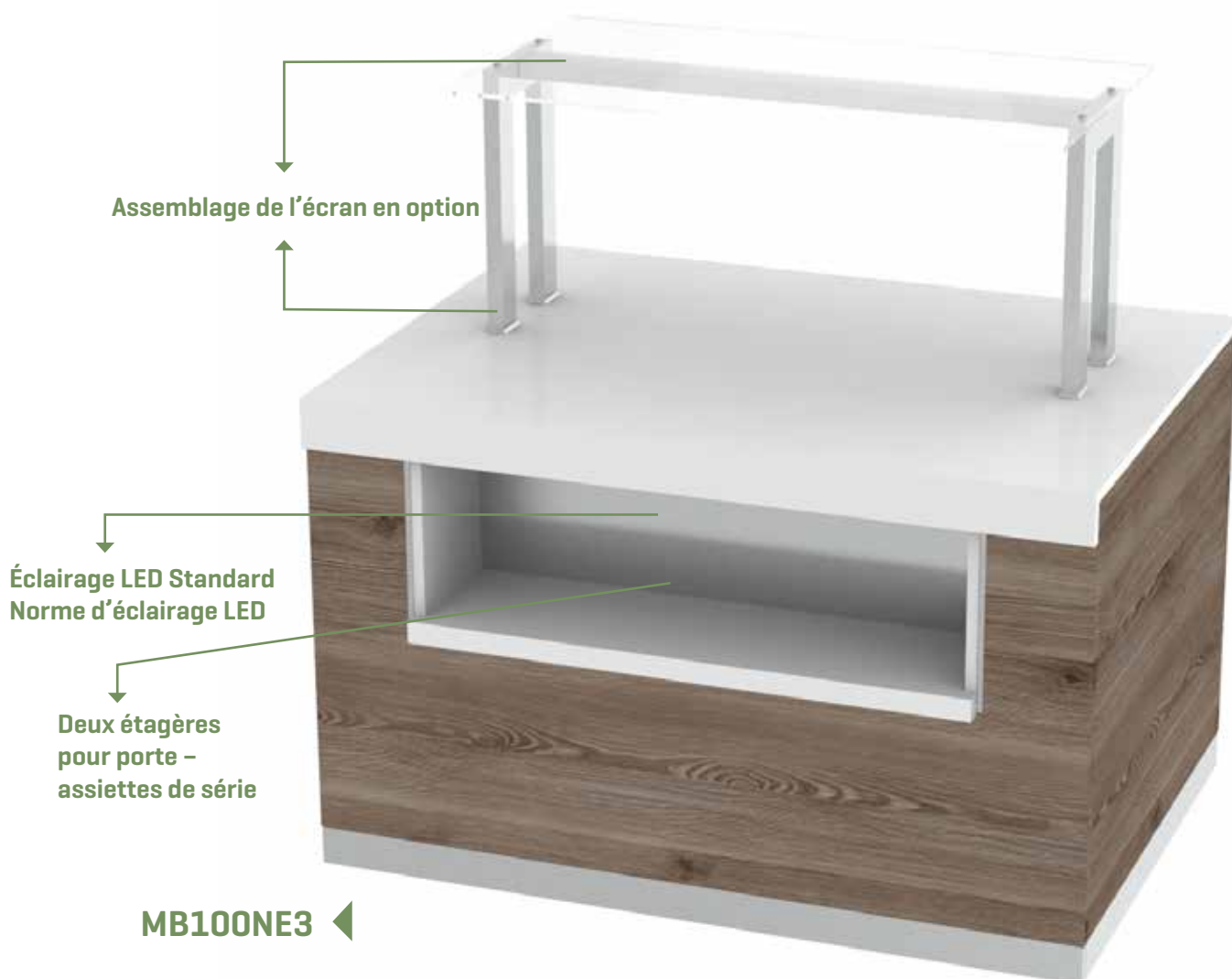

Série Terminales Modèles



MB80TL30
300 x 830 x 900 mm



MB80TL80
830 x 830 x 900 mm



MB80ESQ
830 x 830 x 900 mm

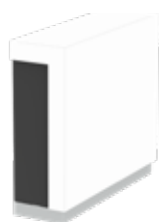

MB100TL30
300 x 1000 x 900 mm



MB100TL100
1000 x 1000 x 900 mm



MB100ESQ
1000 x 1000 x 900 mm

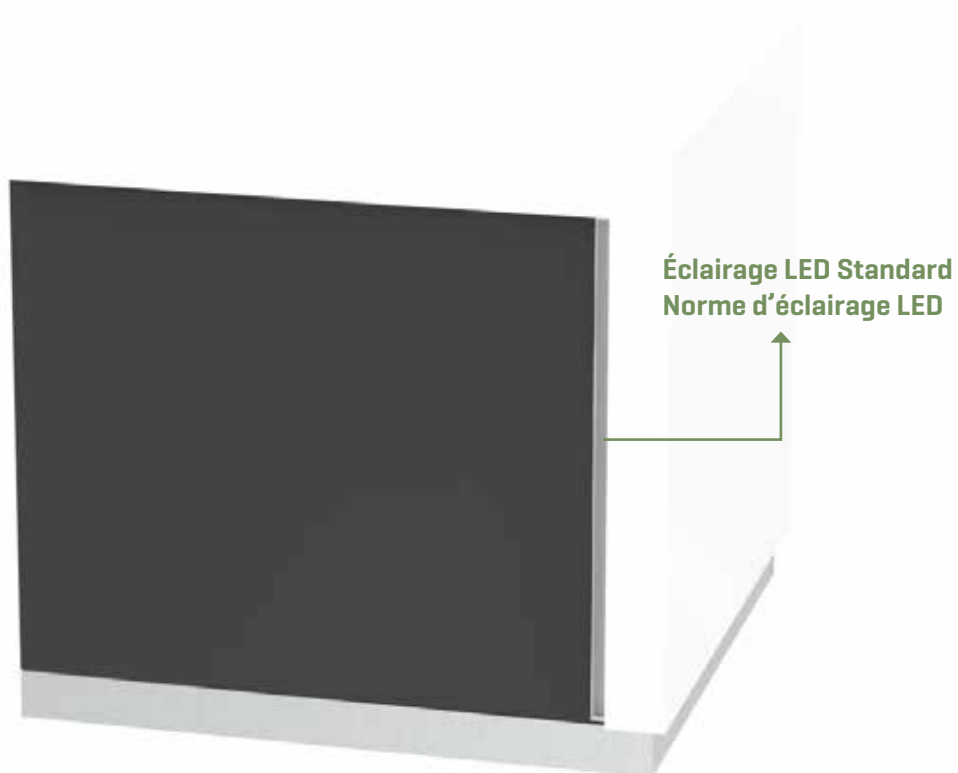

MB100TL100 ◀

Décoration Comptoir

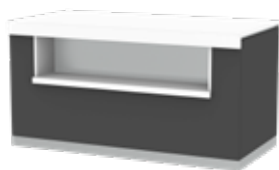

Blanc Standard



Noir

Autre couleur sur demande

AUGMENTATION DU PRIX POUR LE CHANGEMENT DU PLANS DE TRAVAIL

MODÈLES	MB80-2GN / MB80-TL30	MB80-3GN	MB80-4GN	MB80-5GN	MB80-TL80 + Angle /Joues
PRIX					
DIMENSIONS [mm]	830 - 1100 mm Terminal long 300mm	1400 mm	1700 mm	2025 mm	Joues larges 830 mm

AUGMENTATION DU PRIX POUR LE CHANGEMENT DES PLANS DE TRAVAIL

MODÈLES	MB100-2GN / MB100-TL30	MB100-3GN	MB100-4GN	MB100-5GN	MB100-TL100 + Angle /Joues
PRIX					
DIMENSIONS [mm]	1100 mm Terminal long 300 mm	1400 mm	1700 mm	2025 mm	Joues larges 1000 mm

AUGMENTATION DE PRIX PAR LE CHANGEMENT DE COULEUR DU SUPPORT DE LA PLAQUE

MODÈLES	MB80-100-2GN-EST	MB80-100-3GN-EST	MB80-100-4GN-EST	MB80-100-5GN-EST
PRIX				
DIMENSIONS [mm]	1100 mm	1400 mm	1700 mm	2025 mm

Couleur de la Décoration

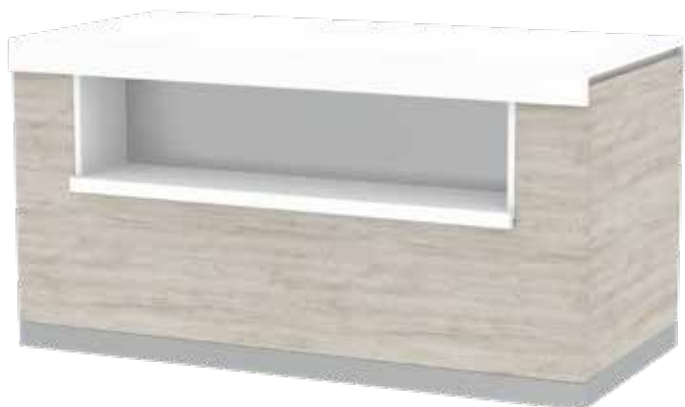

ANNIVERSARY 010AK



Autre couleur consulter le prix
Il peut y avoir une variation entre la couleur de l'impression et la couleur réelle

Composition du jeu d'Écrans

En fonction des besoins, il est possible de procéder aux combinaisons suivantes pour composer un ensemble complet:



(A)

A. *Standard (modèles neutres en option)

- Support à hauteur unique : EEECU1
- Écran: EEPCU
- Dessus en verre : EEVSU

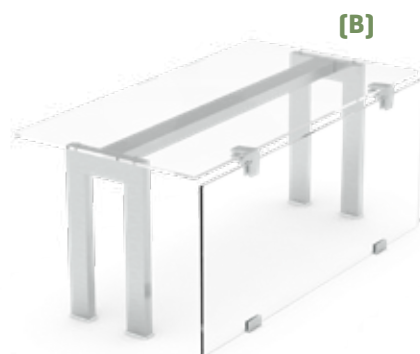

(B)

B. *Standard + vitre frontale

- Support à hauteur unique: EEECU1
- Écran [éclairage+ infrarouge]
- Dessus en verre: EEVSU
- Verre avant: EEVFU



(C)

C. * Support à double hauteur

- Support à double hauteur: EEECU2
- Écran [2 unités] [éclairage + infrarouge]
- Dessus en verre: EEVSU
- Tablette en verre : EEVEU



(D)

D. * Double hauteur et verre frontal

- Support double hauteur: EEECU2
- Écran [2 unités] [éclairage et Infrarouge]
- Verre supérieur: EEVSU
- Tablette en verre: EEVEU
- Verre avant: EEVFU

Supports d'écran



MODÈLES	EEECU1	EEECU2
PRIX		
HAUTEUR (mm)	1	2
MESURES (mm)	260x30x476	260x30x766

EEECU1 est standard, sauf dans les modèles neutres où il est optionnel.

Type d'écrans



[A] Écran (standard) - Écran d'éclairage

	[A] Écran (standard)			
MODÈLES	EEPCU750	EEPCU1125	EEPCU1500	EEPCU2025
PRIX				
MESURES (mm)	710x74x36	1030x74x36	1350x74x36	1675x74x36
Pour les modules de:	1100 (2GN)	1400 (3GN)	1700 (4GN)	2025 (5GN)

	[A] Écran D'éclairage			
MODÈLES	EEKIU750	EEKIU1125	EEKIU1500	EEKIU2025
PRIX				
MESURES (mm)	710x74x36	1030x74x36	1350x74x36	1675x74x36
Pour les modules de:	1100 (2GN)	1400 (3GN)	1700 (4GN)	2025 (5GN)



[B] Écran infrarouge

	[B] Écran Infrarouge			
MODÈLES	EEKIRU750	EEKIRU1125	EEKIRU1500	EEKIRU2025
PRIX				
MESURES (mm)	710x155x74	1030x155x74	1350x155x74	1675x155x74
PUISSANCE	500 W	1000 W	1500 W	2000 W
Pour les modules de:	1100 (2GN)	1400 (3GN)	1700 (4GN)	2025 (5GN)



[C] Eclairage et écran infrarouge

	[C] Éclairage Et Écran Infrarouge			
MODÈLES	EEKIRLU750	EEKIRLU1125	EEKIRLU1500	EEKIRLU2025
RIX				
MESURES (mm)	710x248x74	1030x248x74	1350x248x74	1675x248x74
PUISSANCE	500 W	1000 W	1500 W	2000 W
Pour les modules de:	1100 [2GN]	1400 [3GN]	1700 [4GN]	2025 [5GN]



[D] Plateau en verre supérieur [standard]

	[D] PLATEAU EN VERRE SUPERIEUR [standard]			
MODÈLES	EEVSU750	EEVSU1125	EEVSU1500	EEVSU2025
RIX				
MESURES (mm)	790x590x8	1110x590x8	1430x590x8	1755x590x8
Pour les modules de:	1100 [2GN]	1400 [3GN]	1700 [4GN]	2025 [5GN]



[E] Étagère en verre

	[E] Étagère en Verre			
MODÈLES	EEVEU750	EEVEU1125	EEVEU1500	EEVEU2025
RIX				
MESURES (mm)	705x470x8	1025x470x8	1345x470x8	1670x470x8
Pour les modules de:	1100 [2GN]	1400 [3GN]	1700 [4GN]	2025 [5GN]



[F] Verre frontal

	[F] Vitre frontale			
MODÈLES	EEVFU750	EEVFU1125	EEVFU1500	EEVFU2025
RIX				
MESURES (mm)	790x460x8	1110x460x8	1430x460x8	1755x460x8
Pour les modules de:	1100 [2GN]	1400 [3GN]	1700 [4GN]	2025 [5GN]

3

Drop-in





Elément Encastrable Bain Marie Ventilé Modèles

Bain à remous Marie



EEBM2



EEBM3



EEBM4



EEBM5

Eléments Encastrables Bain Marie Ventilé



EEBMV3



EEBMV4



► EEBM4



MODÈLES	PRIX	MESURES [mm]	MONTAGE DIM [mm]	TEMPERATURE [°C]	DONNÉES ÉLECTRIQUES	MATÉRIAUX	RÉSERVOIR	PUISSANCE [W]
EEBM2		815 x 650 x 380 mm	780 x 615 mm	+30°C/+90°C	230V / 1ph / 50Hz	AISI 304	2	1500
EEBM3		1135 x 650 x 380 mm	1100 x 615 mm	+30°C/+90°C	230V / 1ph / 50Hz	AISI 304	3	2500
EEBM4		1455 x 650 x 380 mm	1420 x 615 mm	+30°C/+90°C	400V/3ph/ 50Hz	AISI 304	4	3500
EEBM5		1775 x 650 x 380 mm	1740 x 615 mm	+30°C/+90°C	400V/3ph/ 50Hz	AISI 304	5	4500
EEBMV3		1135 x 650 x 460 mm	1100 x 615 mm	+30°C/+90°C	230V / 1ph / 50Hz	AISI 304	3	1040
EEBMV4		1455 x 650 x 460 mm	1420 x 615 mm	+30°C/+90°C	230V / 1ph / 50Hz	AISI 304	4	2080

▶ **EEBMV4**

Eléments Encastrable Plaque Froide Modèles



EEPF3



EEPF4



EEPF5



EECH4



EEPF3 ◀



EEPF4 ◀



MODÈLES	PRIX	MESURES [mm]	MONTAGE DIM [mm]	TEMPERATURE [°C]	DONNÉES ÉLECTRIQUES	MATÉRIAUX	RÉSERVOIR	PUISSANCE [W]	CAPACITÉ DE REFROIDISSEMENT [W A -10°C]
EEPF3		1135 x 650 x 490 mm	1100 x 615 mm	-4°C/+4°C	230V / 1ph / 50Hz	AISI 304	---	223	370
EEPF4		1455 x 650 x 490 mm	1420 x 615 mm	-4°C/+4°C	230V / 1ph / 50Hz	AISI 304	---	223	370
EEPF5		1775 x 650 x 490 mm	1740 x 615 mm	-4°C/+4°C	230V / 1ph / 50Hz	AISI 304	---	382	687
EECH4		815 x 530 x 595 mm	780 x 495 mm	-12°C / -18°C	230V / 1ph / 50Hz	AISI 304	4	309	306

REFRIGÉRANT R290



EECH4 ◀
Crème glacée

Élément Encastrable Cuve Froide Modèles



EECF2



EECF3



EECF4



EECF5



MODÈLES	PRIX	MESURES [mm]	MONTAGE DIM [mm]	TEMPERATURE [°C]	DONNÉES ÉLECTRIQUES	MATÉRIAUX	RÉSERVOIR	PUISSANCE [W]	CAPACITÉ DE REFRIGÉRISSMENT [W A -10°C]
EECF2		815 x 650 x 645 mm	780 x 615 mm	+2°C/+10°C	230V / 1ph / 50Hz	AISI 304	2	223	370
EECF3		1135 x 650 x 645 mm	1100 x 615 mm	+2°C/+10°C	230V / 1ph / 50Hz	AISI 304	3	223	370
EECF4		1455 x 650 x 645 mm	1420 x 615 mm	+2°C/+10°C	230V / 1ph / 50Hz	AISI 304	4	223	370
EECF5		1775 x 650 x 645 mm	1740 x 615 mm	+2°C/+10°C	230V / 1ph / 50Hz	AISI 304	5	382	687

REFRIGÉRANT R290



EECF3 ◀



EECF4 ◀



EECF5 ◀

Éléments Encastrables Cuve Froid Ventilé Modèles



EECFV3



EECFV4



EECFV5



MODÈLES	PRIX	MESURES [mm]	MONTAGE DIM [mm]	TEMPERATURE [°C]	DONNÉES ÉLECTRIQUES	MATÉRIAUX	RÉSERVOIR	PUISSANCE [W]	CAPACITÉ DE REFOUILLISSEMENT [W A -10°C]
EECFV3		1155 x 745 x 800 mm	1100 x 690 mm	+2°C/+10°C	230V / 1ph / 50Hz	AISI 304	3	637	687
EECFV4		1475 x 745 x 800 mm	1420 x 690 mm	+2°C/+10°C	230V / 1ph / 50Hz	AISI 304	4	637	687
EECFV5		1804 x 745 x 800 mm	1750 x 690 mm	+2°C/+10°C	230V / 1ph / 50Hz	AISI 304	5	1212	1296

REFRIGÉRANT R290

EECFV3 ◀



EECFV5 ◀

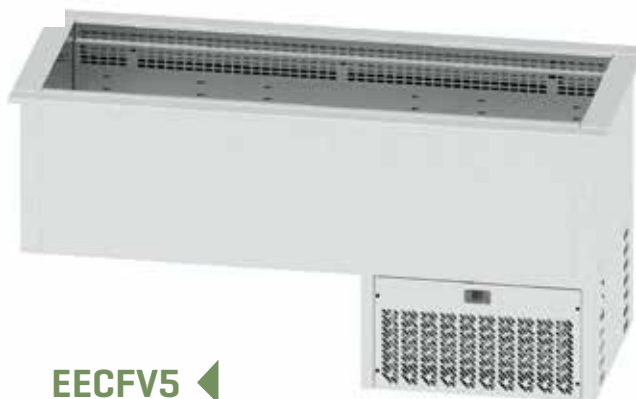

Vitrine avec Eléments Encastrable avec Rideaux / Vitrine avec Vitre Frontale à Charnière Modèles



EEVMC3



EEVMC4



EEVAV3



EEVAV4



EEVAB3



EEVAB4

Éclairage LED Standard
Norme d'éclairage LED ←



EEVMC3 ◀



MODÈLES	PRIX	MESURES [mm]	MONTAGE DIM [mm]	TEMPERATURE [°C]	DONNÉES ÉLECTRIQUES	MATÉRIAUX	RÉSERVOIR	PUISSANCE [W]	CAPACITÉ DE REFFROIDISSEMENT [W A -10°C]
EEVMC3		1135 x 765 x 1537 mm	1100 x 690 mm	+4°C/+12°C	230V / 1ph / 50Hz	AISI 304	3	1246	1296
EEVMC4		1455 x 765 x 1537 mm	1420 x 690 mm	+4°C/+12°C	230V / 1ph / 50Hz	AISI 304	4	1646	1805
EEVAV3		1135 x 765 x 1215 mm	1100 x 690 mm	-4°C/+12°C	230V / 1ph / 50Hz	AISI 304	3	804	951
EEVAV4		1455 x 765 x 1215 mm	1420 x 690 mm	-4°C/+12°C	230V / 1ph / 50Hz	AISI 304	4	1000	1296
EEVAB3		1135 x 765 x 777 mm	1100 x 690 mm	-4°C/+12°C	230V / 1ph / 50Hz	AISI 304	3	437	687
EEVAB4		1455 x 765 x 777 mm	1420 x 690 mm	-4°C/+12°C	230V / 1ph / 50Hz	AISI 304	4	437	687

REFRIGÉRANT R290



► EEVAV4

Plaque de Cuisson Vitrocéramique Encastrable Modèles



EEVC2



EEVC3



EEVC4



MODÈLES	PRIX	MESURES [mm]	MONTAGE DIM [mm]	TEMPERATURE [°C]	DONNÉES ÉLECTRIQUES	MATÉRIAUX	RÉSERVOIR	PUISSANCE [W]
EEVC2		815 x 650 x 225 mm	780 x 615 mm	Max. +130°C	230V / 1ph / 50Hz	AISI 304	---	900
EEVC3		1135 x 650 x 225 mm	1100 x 615 mm	Max. +130°C	230V / 1ph / 50Hz	AISI 304	---	1350
EEVC4		1455 x 650 x 225 mm	1420 x 615 mm	Max. +130°C	230V / 1ph / 50Hz	AISI 304	---	1800



Composition du jeu d'Écrans

En fonction des besoins, il est possible de procéder aux combinaisons suivantes pour composer un ensemble complet:



(A)

A. *Standard (modèles neutres en option)

- Support à hauteur unique : EEECU1
- Écran: EEPCU
- Dessus en verre : EEVSU

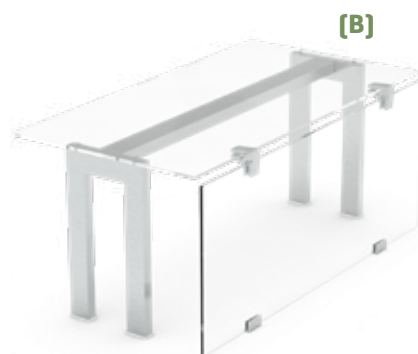

(B)

B. *Standard + vitre frontale

- Support à hauteur unique: EEECU1
- Écran (éclairage+ infrarouge)
- Dessus en verre: EEVSU
- Verre avant: EEVFU



(C)

C. * Support à double hauteur

- Support à double hauteur: EEECU2
- Écran [2 unités] [éclairage + infrarouge]
- Dessus en verre: EEVSU
- Tablette en verre : EEVEU



(D)

D. * Double hauteur et verre frontal

- Support double hauteur: EEECU2
- Écran [2 unités] [éclairage et Infrarouge]
- Verre supérieur: EEVSU
- Tablette en verre: EEVEU
- Verre avant: EEVFU

Supports d'écran



MODÈLES	EEECU1	EEECU2
PRIX		
HAUTEUR (mm)	1	2
MESURES (mm)	260x30x476	260x30x766

Type d'écrans



[A] Écran (standard) - Écran d'éclairage

	[A] Écran (standard)			
MODÈLES	EEPCU750	EEPCU1125	EEPCU1500	EEPCU2025
PRIX				
MESURES (mm)	710x74x36	1030x74x36	1350x74x36	1675x74x36
Pour les modules de:	1100 (2GN)	1400 (3GN)	1700 (4GN)	2025 (5GN)

	[A] Écran D'éclairage			
MODÈLES	EEKIU750	EEKIU1125	EEKIU1500	EEKIU2025
PRIX				
MESURES (mm)	710x74x36	1030x74x36	1350x74x36	1675x74x36
Pour les modules de:	1100 (2GN)	1400 (3GN)	1700 (4GN)	2025 (5GN)



[B] Écran infrarouge

	[B] Écran Infrarouge			
MODÈLES	EEKIRU750	EEKIRU1125	EEKIRU1500	EEKIRU2025
PRIX				
MESURES (mm)	710x155x74	1030x155x74	1350x155x74	1675x155x74
PUISSANCE	500 W	1000 W	1500 W	2000 W
Pour les modules de:	1100 (2GN)	1400 (3GN)	1700 (4GN)	2025 (5GN)



[C] Eclairage et écran infrarouge

	[C] Éclairage Et Écran Infrarouge			
MODÈLES	EEKIRLU750	EEKIRLU1125	EEKIRLU1500	EEKIRLU2025
PRIX				
MESURES (mm)	710x248x74	1030x248x74	1350x248x74	1675x248x74
PUISSANCE	500 W	1000 W	1500 W	2000 W
Pour les modules de:	1100 [2GN]	1400 [3GN]	1700 [4GN]	2025 [5GN]



[D] Plateau en verre supérieur [standard]

	[D] PLATEAU EN VERRE SUPERIEUR [standard]			
MODÈLES	EEVSU750	EEVSU1125	EEVSU1500	EEVSU2025
PRIX				
MESURES (mm)	790x590x8	1110x590x8	1430x590x8	1755x590x8
Pour les modules de:	1100 [2GN]	1400 [3GN]	1700 [4GN]	2025 [5GN]



[E] Étagère en verre

	[E] Étagère en Verre			
MODÈLES	EEVEU750	EEVEU1125	EEVEU1500	EEVEU2025
PRIX				
MESURES (mm)	705x470x8	1025x470x8	1345x470x8	1670x470x8
Pour les modules de:	1100 [2GN]	1400 [3GN]	1700 [4GN]	2025 [5GN]



[F] Verre frontal

	[F] Vitre frontale			
MODÈLES	EEVFU750	EEVFU1125	EEVFU1500	EEVFU2025
PRIX				
MESURES (mm)	790x460x8	1110x460x8	1430x460x8	1755x460x8
Pour les modules de:	1100 [2GN]	1400 [3GN]	1700 [4GN]	2025 [5GN]

Drop In Chaud

Cuisinière à Gaz Modèles



Plan de cuisson au gaz
2 feux

EEDCPG35G

Cuisinière Électrique Modèles



Plan de montage électrique
2 feux diamètre 220mm

EEDPC35E0

Cuisinière Vitrocéramique Modèles



Plan de cuisson
Vitrocéramique
2 feux

EEDPCC35E0



Plan de cuisson au gaz
4 feux

EEDCPG70G



Plan de chauffage
électrique 4 feux diamètre
220mm

EEDPC70E0



Plan de cuisson
Vitrocéramique
4 feux

EEDPCC70E0



► **EEDCPG35G**



EEDPC35E0 ◀



	MODÈLES	PRIX	MESURES [mm]	MESURES ENCASTRABLE [mm]	DONNÉES ÉLECTRIQUES	PUISSANCE DE FEU [KW]	PUISSANCE TOTALE [Kw]	PLAQUES
Cuisson au Gaz	EEDCPG35G		350 x 600 x 307 mm	340 x 590 mm	---	3,3 Kw + 5,2 KW	8,5 KW	2
	EEDCPG70G		700 x 600 x 307 mm	690 x 590 mm	---	2 de 3,3 KW + 2 de 5,2 KW	17 KW	4
Cuisson Électrique	EEDPC35E0		350 x 600 x 266 mm	340 x 590 mm	400V/2N/50-60Hz	2,6 Kw+2,6 KW	5,2 KW	2
	EEDPC70E0		700 x 600 x 266 mm	690 x 590 mm	400V/3N/50-60Hz	4 de 2,6 KW	10,4KW	4
Cuisson Vitrocéramique	EEDPCC35E0		350 x 600 x 266 mm	340 x 590 mm	400V/2N/50-60Hz	1,8 Kw + 2,5 KW	4,3 KW	2
	EEDPCC70E0		700 x 600 x 266 mm	690 x 590 mm	400V/3N/50-60Hz	2 de 1,8 KW + 2 de 2,5 KW	8,6KW	4

► EEDPCC70E0



Drop In Chaud

Cuisinière à Induction Modèles



Plan de cuisson Induction
2 feux

EEDPIN35E

Bain Marie Électrique Modèles



GN 1/1 Bain Marie
électrique

EEDBM35E0

Réserve Chaud pour Les Frites Modèles



GN 2/3 Réserve de chaleur
électrique pour les frites

EEDSP35E0



Friteuses électriques
8L

EEDFR35ES0



Bain Marie électrique
GN 2/1

EEDBM70E0



8L + 8L Plaques de cuisson
électriques

EEDFR35ES0

EEDSP35E0 ◀



▶ **EEDPIN35E**





	MODÈLES	PRIX	MESURES [mm]	MESURES ENCASTRABLE [mm]	DONNÉES ÉLECTRIQUES	PUISSANCE DE FEU [KW]	PUISSANCE TOTALE [Kw]	PLAQUES
Cuisinière à induction	EEDPIN35E		350 x 650 x 295 mm	340 x 590 mm	400V/3N/50-60Hz	3,5Kw+3,5KW	7 KW	2
	EEDFR35ESO		350 x 600 x 330 mm	340 x 590 mm	400V/3N/50-60Hz	7,5 KW	7,5 KW	1
Bain Marie électrique	EEDFR35ESO		700 x 600 x 330 mm	690 x 590 mm	400V/3N/50-60Hz	7,5Kw+7,5KW	15 KW	2
	EEDBM35EO		350 x 600 x 266 mm	340 x 590 mm	230V/50-60Hz	1,3KW	1,3KW	1
	EEDBM70EO		700 x 600 x 266 mm	690 x 590 mm	230V/50-60Hz	2,6KW	2,6KW	1
Réserve chaude pour les frites	EEDSP35EO		350 x 600 x 266 mm	340 x 590 mm	220-240V/50-60Hz	0,65KW	0,65 KW	1



► EEDFR35ESO

Drop In Chaud

Cuiseur de Pâtes Électrique Modèles



23L GN 2/3
Cuiseur de pâtes électrique

EEDCP35E0

Plancha Électrique Lisse Modèles



Gril plat électrique

EEDFTL35E0

Accessoires pour Cuiseur de Pâtes Électrique Modèles

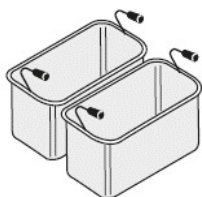

2 paniers GN 1/3

EE120620



4 paniers GN 1/6

EE120625



Double friteuse Gril plat
électrique

EEDFTL70E0

► **EEDCP35E0**



► **EEDFTL35E0**





	MODÈLES	PRIX	MESURES [mm]	MESURES ENCASTRABLE [mm]	DONNÉES ÉLECTRIQUES	PUISSANCE DE FEU [KW]	PUISSANCE TOTALE [Kw]	PLAQUES
Cuisseur de Pâtes Électrique	EEDCP35E0		350 x 600 x 320 mm	340 x 590 mm	400V/3N/ 50-60Hz	4,8KW	4,8KW	1
Acc pour Cuisseur de Pâtes Électrique	EE120620		290 x 160 x 200 mm	-----	-----	-----	-----	-----
	EE120625		140 x 140 x 200 mm	-----	-----	-----	-----	-----
Fry Top Electrico	EEDFTL35E0		350 x 600 x 266 mm	340 x 590 mm	400V/2N/ 50-60Hz	-----	3,9 KW	1
	EEDFTL70E0		700 x 600 x 266 cm	690 x 590 mm	400V/3N/ 50-60Hz	-----	7,8 KW	2



► **EEDFTL70E0**

4

Self Service





Self Service Cuve Froide · Plaques Froides Modèles



SSCFA3



SSCFA4



SSCFA6



SSCFF4



SSCFF6



SSPFA3



SSPFA4



SSPFA6



SSPFF4



SSPFF6

SSCFA3 ◀





MODÈLES	PRIX	MESURES (mm)	TEMPERATURE (°C)	CLIMATIQUE CLASSE (°C)	RESERVE FROIDE (°C)	DONNÉES ÉLECTRIQUES	MATÉRIAUX	RÉSERVOIR	PORTES	PUISSANCE (W)	CAPACITÉ DE REFROIDISSEMENT (W A -10°C)
SSCFA3		1125 x 800 x 900 mm	+2°C/+10°C	4 / 38°C	---	230V/1ph/50Hz	AISI 304	3 GN	---	223	370
SSCFA4		1500 x 800 x 900 mm	+2°C/+10°C	4 / 38°C	---	230V/1ph/50Hz	AISI 304	4 GN	---	223	370
SSCFA6		2250 x 800 x 900 mm	+2°C/+10°C	4 / 38°C	---	230V/1ph/50Hz	AISI 304	6 GN	---	382	687
SSCFF4		1500 x 800 x 900 mm	+2°C/+10°C	4 / 38°C	0°C/+6°C	230V/1ph/50Hz	AISI 304	4 GN	2	528	687
SSCFF6		2250 x 800 x 900 mm	+2°C/+10°C	4 / 38°C	0°C/+6°C	230V/1ph/50Hz	AISI 304	6 GN	3	661	951
SSPFA3		1125 x 800 x 900 mm	-4°C/+4°C	4 / 38°C	---	230V/1ph/50Hz	AISI 304	3 GN	---	223	370
SSPFA4		1500 x 800 x 900 mm	-4°C/+4°C	4 / 38°C	---	230V/1ph/50Hz	AISI 304	4 GN	---	223	370
SSPFA6		2250 x 800 x 900 mm	-4°C/+4°C	4 / 38°C	---	230V/1ph/50Hz	AISI 304	6 GN	---	382	687
SSPFF4		1500 x 800 x 900 mm	-4°C/+4°C	4 / 38°C	0°C/+6°C	230V/1ph/50Hz	AISI 304	4 GN	2	528	687
SSPFF6		2250 x 800 x 900 mm	-4°C/+4°C	4 / 38°C	0°C/+6°C	230V/1ph/50Hz	AISI 304	6 GN	3	661	951

REFRIGERANT R290

► SSCFF6



Vitrine Cuve Froide · Plaque Froide Modèles



SSCFAV4



SSCFAV6



SSCFFV4



SSCFFV6



SSPFAV4



SSPFAV6



SSPFFV4



SSPFFV6

SSCFAV6 ◀





MODÈLES	PRIX	MESURES (mm)	TEMPERATURE (°C)	CLIMATIQUE CLASSE	RESERVE FROIDE (°C)	DONNÉES ÉLECTRIQUES	MATÉRIAUX	RÉSERVOIR	PORTES	PUISSANCE (W)	CAPACITÉ DE REFROIDISSEMENT (W A -10°C)
SSCFAV4		1500 x 800 x 1890 mm	Cuba Froid +2°C/+10°C Vitrine +4°C/+12°C	4 / 38°C	---	230V/1ph/50Hz	AISI 304	4 GN	---	969	1048
SSCFAV6		2250 x 800 x 1890 mm	Cuba Froid +2°C/+10°C Vitrine +4°C/+12°C	4 / 38°C	---	230V/1ph/50Hz	AISI 304	6 GN	---	1234	1425
SSCFFV4		1500 x 800 x 1890 mm	Cuba Froid +2°C/+10°C Vitrine +4°C/+12°C	4 / 38°C	0°C/+6°C	230V/1ph/50Hz	AISI 304	4 GN	2	841	1041
SSCFFV6		2250 x 800 x 1890 mm	Cuba Froid +2°C/+10°C Vitrine +4°C/+12°C	4 / 38°C	0°C/+6°C	230V/1ph/50Hz	AISI 304	6 GN	3	1136	1446
SSPFAV4		1500 x 800 x 1890 mm	Plaque Froide -4°C/+4°C Vitrine +4°C/+12°C	4 / 38°C	---	230V/1ph/50Hz	AISI 304	4 GN	---	618	951
SSPFAV6		2250 x 800 x 1890 mm	Plaque Froide -4°C/+4°C Vitrine +4°C/+12°C	4 / 38°C	---	230V/1ph/50Hz	AISI 304	6 GN	---	976	1446
SSPFFV4		1500 x 800 x 1890 mm	Plaque Froide -4°C/+4°C Vitrine +4°C/+12°C	4 / 38°C	0°C/+6°C	230V/1ph/50Hz	AISI 304	4 GN	2	724	1041
SSPFFV6		2250 x 800 x 1890 mm	Plaque Froide -4°C/+4°C Vitrine +4°C/+12°C	4 / 38°C	0°C/+6°C	230V/1ph/50Hz	AISI 304	6 GN	3	1004	1446

REFRIGERANT R290

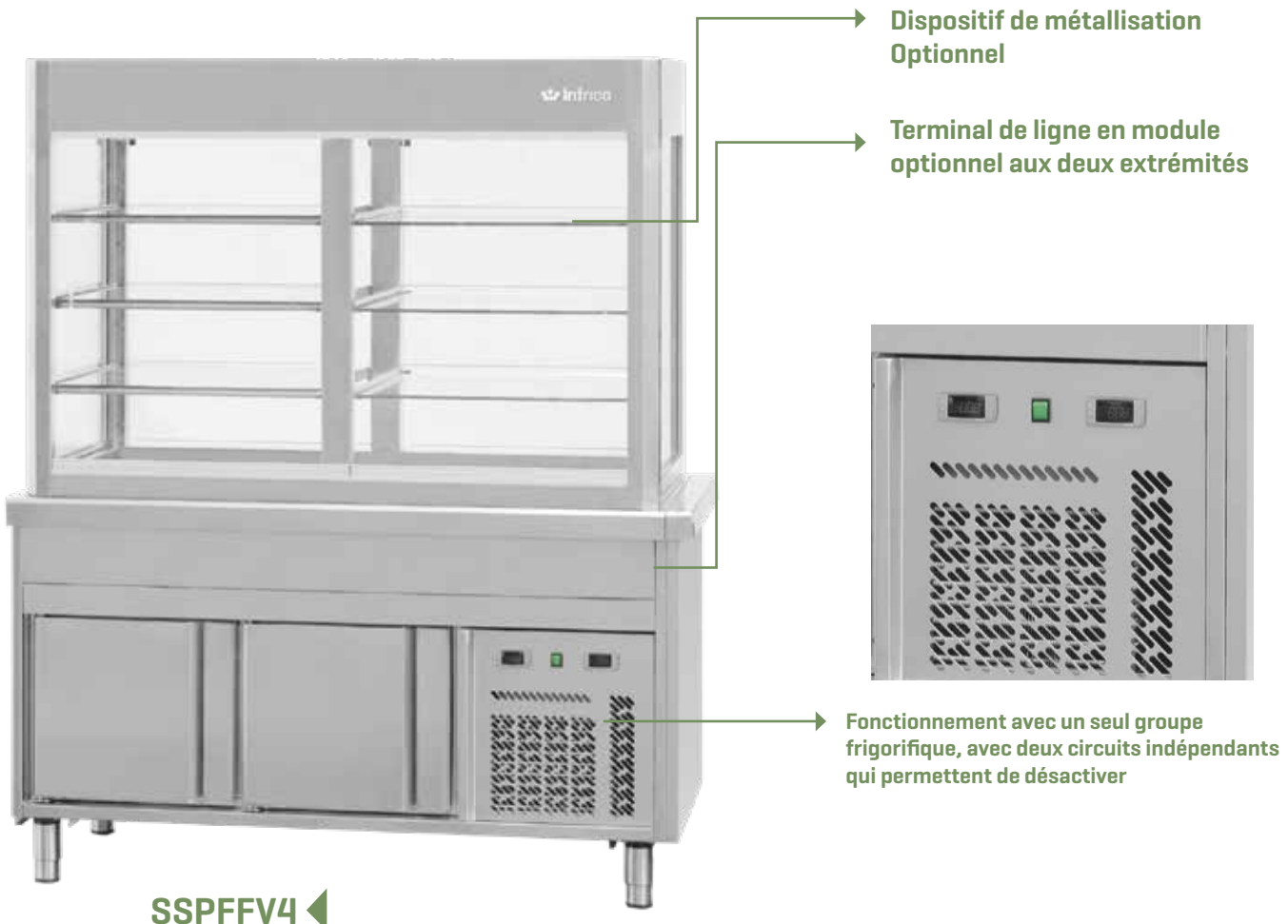

SSPFFV4 ◀

Vitrine Refrigeration 3 Niveaux Modèles



SSVSFCG4



SSVSFCG6



SSVCFCG4



SSVCFCG6



SSPFAVA3



SSPFAVA4



SSVASF3



SSVASF4

Dispositif de métallisation
optionnel
Méthacrylate de plateau en
option



SSVSFCG4 ◀





MODÈLES	PRIX	MESURES (mm)	TEMPERATURE (°C)	CLIMATIQUE CLASSE (°C)	DONNÉES ÉLECTRIQUES	MATÉRIAUX	PUISSANCE (W)	CAPACITÉ DE REFROIDISSEMENT (W A -10°C)
SSVSFCG4		1450 x 730 x 1262 mm	+4°C/+12°C	4 / 38°C	230V/1ph/50Hz	AISI 304	618	951
SSVSFCG6		2200 x 730 x 1262 mm	+4°C/+12°C	4 / 38°C	230V/1ph/50Hz	AISI 304	976	1446
SSVCFCG4		1450 x 730 x 1262 mm	+4°C/+12°C	4 / 38°C	230V/1ph/50Hz	AISI 304	618	951
SSVCFCG6		2200 x 730 x 1262 mm	+4°C/+12°C	4 / 38°C	230V/1ph/50Hz	AISI 304	976	1446
SSPFAVA3		1125 x 800 x 2100 mm	+4°C/+12°C	4 / 38°C	230V/1ph/50Hz	AISI 304	1376	2150
SSPFAVA4		1500 x 800 x 1815 mm	+4°C/+12°C	4 / 38°C	230V/1ph/50Hz	AISI 304	1415	2150
SSVASF3		1112 x 745 x 1212 mm	+4°C/+12°C	4 / 38°C	230V/1ph/50Hz	AISI 304	1330	1805
SSVASF4		1487 x 745 x 1212 mm	+4°C/+12°C	4 / 38°C	230V/1ph/50Hz	AISI 304	1330	1805

REFRIGERANT R290

Temps de service 2h



▶ SSPFAVA4

Bain Marie Sur Meuble Chauffant · Bain Marie Sur Meuble Neutre Modèles



SSBMC3



SSBMC4



SSBMC6



SSBMA2



SSBMA3



SSBMA4



SSBMA6



SSBMN3



SSBMN4



SSBMN6

SSBMC4 ◀





MODÈLES	PRIX	MESURES (mm)	TEMPERATURE [°C]	CLIMATIQUE CLASSE [°C]	RESERVE FROIDE [°C]	DONNÉES ÉLECTRIQUES	MATÉRIAUX	RÉSERVOIR	PORTES	PUISSANCE [W]
SSBMC3		1125 x 800 x 900 mm	+30°C/+90°C	4 / 38°C	+30°C/+90°C	400V/ 3ph/ 50Hz	AISI 304	3 GN	2	3500
SSBMC4		1500 x 800 x 900 mm	+30°C/+90°C	4 / 38°C	+30°C/+90°C	400V/ 3ph/ 50Hz	AISI 304	4 GN	2	4500
SSBMC6		2250 x 800 x 900 mm	+30°C/+90°C	4 / 38°C	+30°C/+90°C	400V/ 3ph/ 50Hz	AISI 304	6 GN	2	6000
SSBMA2		850 x 800 x 900 mm	+30°C/+90°C	4 / 38°C	---	230V/ 1ph/ 50Hz	AISI 304	2 GN	---	1500
SSBMA3		1125 x 800 x 900 mm	+30°C/+90°C	4 / 38°C	---	230V/ 1ph/ 50Hz	AISI 304	3 GN	---	2500
SSBMA4		1500 x 800 x 900 mm	+30°C/+90°C	4 / 38°C	---	400V/ 3ph/ 50Hz	AISI 304	4 GN	---	3500
SSBMA6		2250 x 800 x 900 mm	+30°C/+90°C	4 / 38°C	---	400V/ 3ph/ 50Hz	AISI 304	6 GN	---	5000
SSBMN3		1125 x 800 x 900 mm	+30°C/+90°C	4 / 38°C	---	230V/ 1ph/ 50Hz	AISI 304	3 GN	2	2500
SSBMN4		1500 x 800 x 900 mm	+30°C/+90°C	4 / 38°C	---	400V/ 3ph/ 50Hz	AISI 304	4 GN	2	3500
SSBMN6		2250 x 800 x 900 mm	+30°C/+90°C	4 / 38°C	---	400V/ 3ph/ 50Hz	AISI 304	6 GN	2	5000



► SSBMN4

Bain Marie Sec Ventilé · Vitrocéramique Modèle



SSBMVA3



SSBMVA4



SSBMVC3



SSBMVC4



SSVCA2



SSVCA3



SSVCA4



SSVCN3



SSVCN4



SSVCC3



SSVCC4



▶ SSBMVA4



MODÈLES	PRIX	MESURES [mm]	TEMPERATURE [°C]	CLIMATIQUE CLASSÉ [°C]	RESERVE FROIDE [°C]	DONNÉES ÉLECTRIQUES	MATÉRIAUX	RÉSERVOIR	PORTES	PUISSANCE [W]
SSBMVA3		1125 x 800 x 900 mm	+30°C/+90°C	4 / 38°C	---	230V/ 1ph/ 50Hz	AISI 304	3 GN	---	2040
SSBMVA4		1500 x 800 x 900 mm	+30°C/+90°C	4 / 38°C	---	400V/ 3ph/ 50Hz	AISI 304	4 GN	---	4040
SSBMVC3		1125 x 800 x 900 mm	+30°C/+90°C	4 / 38°C	+30°C/+90°C	230V/ 1ph/ 50Hz	AISI 304	3 GN	2	3060
SSBMVC4		1500 x 800 x 900 mm	+30°C/+90°C	4 / 38°C	+30°C/+90°C	400V/ 3ph/ 50Hz	AISI 304	4 GN	2	5060
SSVCA2		850 x 800 x 900 mm	+30°C/+90°C Max. 130°C	4 / 38°C	---	230V/ 1ph/ 50Hz	AISI 304	---	---	900
SSVCA3		1125 x 800 x 900 mm	+30°C/+90°C Max. 130°C	4 / 38°C	---	230V/ 1ph/ 50Hz	AISI 304	---	---	1350
SSVCA4		1500 x 800 x 900 mm	+30°C/+90°C Max. 130°C	4 / 38°C	---	230V/ 1ph/ 50Hz	AISI 304	---	---	1800
SSVCN3		1125 x 800 x 900 mm	+30°C/+90°C Max. 130°C	4 / 38°C	---	230V/ 1ph/ 50Hz	AISI 304	---	2	1350
SSVCN4		1500 x 800 x 900 mm	+30°C/+90°C Max. 130°C	4 / 38°C	---	230V/ 1ph/ 50Hz	AISI 304	---	2	1800
SSVCC3		1125 x 800 x 900 mm	+30°C/+90°C Max. 130°C	4 / 38°C	+30°C/+90°C	230V/ 1ph/ 50Hz	AISI 304	---	2	2370
SSVCC4		1500 x 800 x 900 mm	+30°C/+90°C Max. 130°C	4 / 38°C	+30°C/+90°C	230V/ 1ph/ 50Hz	AISI 304	---	2	2820

Structure double hauteur [optionnelle]

SSVCA3



Tables Chaudes · Neutre Modèles



SSNEC3



SSNEC4



SSNEC6



SSNEA2



SSNEA3



SSNEA4



SSNEA6



SSNEN3



SSNEN4



SSNEN6



► **SSNEC4**

Terminal de ligne de série dans la table de cuisson
Panneau latéral d'extrémité inclus dans la table
chaude



MODÈLES	PRIX	MESURES [mm]	TEMPERATURE [°C]	CLIMATIQUE CLASSE [°C]	RESERVE FROIDE [°C]	DONNÉES ÉLECTRIQUES	MATÉRIAUX	PORTES	PUISSANCE [W]
SSNEC3		1125 x 800 x 900 mm	+30°C/+90°C	4 / 38°C	+30°C/+90°C	230V/ 1ph/ 50Hz	AISI 304	2	1020
SSNEC4		1500 x 800 x 900 mm	+30°C/+90°C	4 / 38°C	+30°C/+90°C	230V/ 1ph/ 50Hz	AISI 304	2	1020
SSNEC6		2250 x 800 x 900 mm	+30°C/+90°C	4 / 38°C	+30°C/+90°C	230V/ 1ph/ 50Hz	AISI 304	2	1020
SSNEA2		750 x 800 x 900 mm	---	---	---	---	AISI 304	---	---
SSNEA3		1125 x 800 x 900 mm	---	---	---	---	AISI 304	---	---
SSNEA4		1500 x 800 x 900 mm	---	---	---	---	AISI 304	---	---
SSNEA6		2250 x 800 x 900 mm	---	---	---	---	AISI 304	---	---
SSNEN3		1125 x 800 x 900 mm	---	---	---	---	AISI 304	2	---
SSNEN4		1500 x 800 x 900 mm	---	---	---	---	AISI 304	2	---
SSNEN6		2250 x 800 x 900 mm	---	---	---	---	AISI 304	2	---

SSNEA4 ◀



SSNEA2 ◀



Unités Neutres Modèles

AUTO ANGULAIRE



SSAA90

1608 x 800 x 900 mm



SSAC90

1608 x 800 x 900 mm



SSAA45

888 x 800 x 900 mm



SSAC45

888 x 800 x 900 mm

BOÎTE SELF



SSCD

1125 x 800 x 900 mm



SSCI

1125 x 800 x 900 mm



► **SSAA90**
Aves glissière de plateau

Unités Neutres Modèles

DISTRIBUTEUR D'ASSIETTES



SSDPNA2

750 x 800 x 900 mm
2.956 €



SSDPC2

750 x 800 x 900 mm
4.196 €

ADAPTATEUR POUR CHARIOT



SSABA 1

600 x 160 x 900 mm
1.358 €



SSABA 3

1125 x 800 x 900 mm
1.531 €



SSABA 4

1500 x 800 x 900 mm
1.834 €

► SSDPNA2



Composition du jeu d'Écrans

En fonction des besoins, il est possible de procéder aux combinaisons suivantes pour composer un ensemble complet:



(A)

- A.**
***Standard (modèles neutres en option)**
 - Support à hauteur unique : EEECU1
 - Écran: EEPCU
 - Dessus en verre : EEVSU

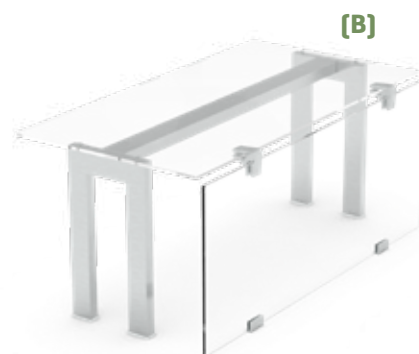

(B)

- B.**
***Standard + vitre frontale**
 - Support à hauteur unique: EEECU1
 - Écran [éclairage+ infrarouge]
 - Dessus en verre: EEVSU
 - Verre avant: EEVFU



(C)

- C.**
*** Support à double hauteur**
 - Support à double hauteur: EEECU2
 - Écran [2 unités] [éclairage + infrarouge]
 - Dessus en verre: EEVSU
 - Tablette en verre : EEVEU



(D)

- D.**
*** Double hauteur et verre frontal**
 - Support double hauteur: EEECU2
 - Écran [2 unités] [éclairage et Infrarouge]
 - Verre supérieur: EEVSU
 - Tablette en verre: EEVEU
 - Verre avant: EEVFU

Supports d'écran



MODÈLES	EEECU1	EEECU2
PRIX		
HAUTEUR [mm]	1	2
MESURES [mm]	260x30x476	260x30x766

Type d'écrans



[A] Écran [standard] - Écran d'éclairage

	[A] Écran [standard]			
MODÈLES	EEPCU750	EEPCU1125	EEPCU1500	EEPCU2025
PRIX				
MESURES [mm]	710x74x36	1030x74x36	1350x74x36	1675x74x36
Pour les modules de:	1100 [2GN]	1400 [3GN]	1700 [4GN]	2025 [5GN]

	[A] Écran D'éclairage			
MODÈLES	EEKIU750	EEKIU1125	EEKIU1500	EEKIU2025
PRIX				
MESURES [mm]	710x74x36	1030x74x36	1350x74x36	1675x74x36
Pour les modules de:	1100 [2GN]	1400 [3GN]	1700 [4GN]	2025 [5GN]



[B] Écran infrarouge

	[B] Écran Infrarouge			
MODÈLES	EEKIRU750	EEKIRU1125	EEKIRU1500	EEKIRU2025
PRIX				
MESURES [mm]	710x155x74	1030x155x74	1350x155x74	1675x155x74
PUISSANCE	500 W	1000 W	1500 W	2000 W
Pour les modules de:	1100 [2GN]	1400 [3GN]	1700 [4GN]	2025 [5GN]



[C] Eclairage et écran infrarouge

[C] Éclairage Et Écran Infrarouge				
MODÈLES	EEKIRLU750	EEKIRLU1125	EEKIRLU1500	EEKIRLU2025
PRIX				
MESURES (mm)	710x248x74	1030x248x74	1350x248x74	1675x248x74
PUISSANCE	500 W	1000 W	1500 W	2000 W
Pour les modules de:	1100 [2GN]	1400 [3GN]	1700 [4GN]	2025 [5GN]



[D] Plateau en verre superieur [standard]

[D] PLATEAU EN VERRE SUPERIEUR [standard]				
MODÈLES	EEVSU750	EEVSU1125	EEVSU1500	EEVSU2025
PRIX				
MESURES (mm)	790x590x8	1110x590x8	1430x590x8	1755x590x8
Pour les modules de:	1100 [2GN]	1400 [3GN]	1700 [4GN]	2025 [5GN]



[E] Étagère en verre

[E] Étagère en Verre				
MODÈLES	EEVEU750	EEVEU1125	EEVEU1500	EEVEU2025
PRIX				
MESURES (mm)	705x470x8	1025x470x8	1345x470x8	1670x470x8
Pour les modules de:	1100 [2GN]	1400 [3GN]	1700 [4GN]	2025 [5GN]



[F] Verre frontal

[F] Vitre frontale				
MODÈLES	EEVFU750	EEVFU1125	EEVFU1500	EEVFU2025
PRIX				
MESURES (mm)	790x460x8	1110x460x8	1430x460x8	1755x460x8
Pour les modules de:	1100 [2GN]	1400 [3GN]	1700 [4GN]	2025 [5GN]

Guides linéaires pour Plateaux

MODÈLES	SSCB600	SSCB750	SSCB1125	SSCB1500	SSCB2250	SSCBAA45	SSCBAA90
---------	---------	---------	----------	----------	----------	----------	----------

PRIX

MESURES [mm]	600 x 390 x 100 mm	750 x 390 x 100 mm	1125 x 390 x 100 mm	1500 x 390 x 100 mm	2250 x 390 x 100 mm	1110 x 390 x 100 mm	2030 x 390 x 100 mm
--------------	--------------------	--------------------	---------------------	---------------------	---------------------	---------------------	---------------------

Bases Intérieures

MODÈLES	SSZC600	SSZC750	SSZC1125	SSZC1500	SSZC2250	SSZCAA90
---------	---------	---------	----------	----------	----------	----------

PRIX

MESURES [mm]	600 x 130 x 45 mm	750 x 130 x 45 mm	1125 x 130 x 45 mm	1500 x 130 x 45 mm	2250 x 130 x 45 mm	610 x 130 x 45 mm
--------------	-------------------	-------------------	--------------------	--------------------	--------------------	-------------------

Bases Intérieures

MODÈLES	SSZCAC90	SSZCAA45	SSZCAC45	SSZCCD	SSZCCI	SSZCL	Angle fermé	
MODÈLES							MODÈLES	SSKSPLP

PRIX

MESURES [mm]	610 x 130 x 45 mm	830 x 130 x 45 mm	345 x 130 x 45 mm	1145 x 130 x 150 mm	1145 x 130 x 150 mm	645 x 130 x 150 mm	MESURES [mm]	560 x 395 x 2260 mm
--------------	-------------------	-------------------	-------------------	---------------------	---------------------	--------------------	--------------	---------------------



Terminal de ligne

MODELE	PRIX	UNITÉS
SSKTL		1

Kit roulettes

MODÈLES	PRIX	UNITÉS
SSKR4		4
SSKR6		6

Série Décoration plastifiée



RAL 2003
Orange

RAL 1018
Jaune

RAL 3003
Marron

RAL 5017
Bleu foncé

RAL 6002
Vert foncé

RAL 9016
Blanc

MODÈLES	SSDP750	SSDP1125	SSDP1500	SSDP2250	SSDPAA90	SSDPAA45	SSDPAC90	SSDPAC45
---------	---------	----------	----------	----------	----------	----------	----------	----------

PRIX

Sas augmentation

MESURES [mm]	750 mm	1125mm	1500 mm	2250 mm	Angle ouvert 90°	Angle ouvert 45°	Angle fermé 90°	Angle fermé 45°
--------------	--------	--------	---------	---------	------------------	------------------	-----------------	-----------------



5



**Chariot
Chaud et
Froids**



Chariot de Banquet Chauffé Modèles



CHARIOT CHAUFFANT
POUR BANQUETS
5 GN 2/1

HT1021



CHARIOT DE BANQUET
CHAUFFÉ
11 GN 2/1

HT2021



CHARIOT DE BANQUET
CHAUFFÉ
11+11 GN 2/1

HT4021



MODELE	PRIX	MESURES (mm)	TEMPERATURE (°C)	DONNÉES ÉLECTRIQUES	CAPACITÉ	PORTES	N° ÉTAGÈRES / GLISSIÈRES	SEPARATION	PUISSANCE (W)
HT1021		910x827x1160 mm	+50°C a +80°C	230V/50-60Hz	310L	1 Ouverture à 270° / Pleine	10 GN 2/1 / 20 GN 1/1	57mm	2000
HT2021		910x827x1816 mm	+50°C a +80°C	230V/50-60Hz	550L	1 Ouverture à 270° / Pleine	22 GN 2/1 / 44 GN 1/1	57mm	2000
HT4021		910x1517x1816 mm	+50°C a +80°C	230V/50-60Hz	1300L	1 Ouverture à 270° / Pleine	22+22 GN 2/1 / 44 + 44 GN 1/1	57mm	2000



► **HT4021**

Chariot de Banquet Chauffé avec Vapeur Modèles



GN 2/1 BANQUET CHAUD
AVEC VAPEUR 10 GN 2/1

HT1021H



GN 2/1 BANQUET CHAUD
AVEC VAPEUR
20 GN 2/1

HT2021H



MODELE	PRIX	MESURES (mm)	TEMPERATURE (°C)	DONNÉES ÉLECTRIQUES	PORTES	N° ÉTAGÈRES / GLISSIÈRES	SEPARATION	PUISSANCE (W)
HT1021H		570x879x1114 mm	+30°C a +85°C	230V/50-60Hz	1 entrée abatible ouverture 270° / Pleine	10 GN 2/1	71mm	1500
HT2021H		570x879x1824 mm	+30°C a +85°C	230V/50-60Hz	1 entrée abatible ouverture 270° / Pleine	20 GN 2/1	71mm	3000



► **HT2021H**

Chariot pour Banquets Froids Modèles



CHARIOT POUR
BANQUETS FROIDS

CT2021



CHARIOT POUR
BANQUETS FROIDS
15 GN 1/1

CT1511



CHARIOT POUR
BANQUETS FROIDS
15 GN 2/1

CT1521



MODELE	PRIX	MESURES (mm)	TEMPERATURE [°C]	DONNÉES ÉLECTRIQUES	CAPACITÉ	PORTES	N° ÉTAGÈRES / GLISSIÈRES	SEPARATION	PUISSANCE (W)
CT2021		910x850x1816 mm	-2°C a +8°C	230V/50-60Hz	500 L	1 porte battante pleine	20GN 2/1	71mm	310
CT1511		570x880x1750 mm	0°C a +10°C	230V/50-60Hz	225 L	1 porte battante pleine	15 GN 1/1	71mm	230
CT1521		775x1000x1755 mm	0°C a +10°C	230V/50-60Hz	440 L	1 porte battante pleine	15 GN 2/1	71mm	250



CT2021 ◀

Chariot pour Banquets Chauds et Froids

Modèles



CHARIOT DE BANQUET CHAUD
ET FROID

MXT1511



MODELE	PRIX	MESURES [mm]	TEMPERATURE [°C]	DONNÉES ÉLECTRIQUES	CAPACITÉ	PORTES	N° ÉTAGÈRES / GLISSIÈRES	SEPARATION	PUISSANCE [W]
MXT1511		570x893x1749 mm	0°C a +85°C	230V/50-60Hz	225L	1 ouverture abatible ciega	15 GN 1/1	71mm	1.850



HOT AND COLD

► **MXT1511**

Distributeur D'assiettes Chauffantes Modèles



DISTRIBUTEUR
D'ASSIETTES CHAUFFÉ
(40 ASSIETTES) ÉLEC

HPT40



DISTRIBUTEUR
D'ASSIETTES CHAUFFÉ
(80 ASSIETTES) ÉLEC.

HPT80



DISTRIBUTEUR
D'ASSIETTES NEUTRE
(40 ASSIETTES)

NPT40



DISTRIBUTEUR
D'ASSIETTES NEUTRE
(80 ASSIETTES)

NPT80



MODELE	PRIX	MESURES [mm]	TEMPERATURE [°C]	DONNÉES ÉLECTRIQUES	CAPACITÉ	PORTES	N° ÉTAGÈRES / GLISSIÈRES	SEPARATION	PUISSANCE [W]
HPT40		440x440x850 mm	+30°C a +90°C	230V/50-60Hz	40 Plats	un dépôt		Diamètre des plateaux de 26 a 32	1500
HPT80		440x780x850 mm	+30°C a +90°C	230V/50-60Hz	80 Plats (40+40)	dos dépôts		Diamètre des plateaux de 26 a 32	3000
NPT40		440x440x851 mm			40 Plats	un dépôt	GN 2/1	Diamètre des plateaux de 26 a 32	
NPT80		440x780x851 mm			80 Plats (40+40)	dos dépôt	15 GN 1/1	Diamètre des plateaux de 26 a 32	



► **HPT40**

Distributeur d'assiettes Encastrable Modèles



DISTRIBUTEUR D'ASSIETTES ENCASTRABLE CHARIOT CHAUFFANT (40 ASSIETTES)

EHPT40



DISTRIBUTEUR D'ASSIETTES ENCASTRABLE CART NEUTRE (40 ASSIETTES)

ENPT40



MODELE	PRIX	MESURES (mm)	TEMPERATURE (°C)	DONNÉES ÉLECTRIQUES	CAPACITÉ	PORTES	N° ÉTAGÈRES / GLISSIÈRES	SEPARATION	PUISSANCE [W]
EHPT40		Diamètre 430 X 850 de hauteur	+30°C a +90°C	230V/50-60Hz	40 Plats	un dépôt		Diamètre des plateaux de 26 a 32	1500
ENPT40		Diamètre 430 X 850 de hauteur			40 Plats	un dépôt		Diamètre des plateaux de 26 a 32	



► **EHPT40**

Chariots a Plateaux Modèles

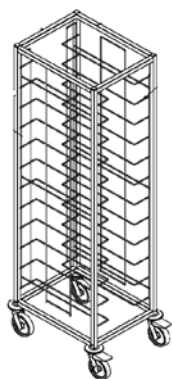

CBA12P

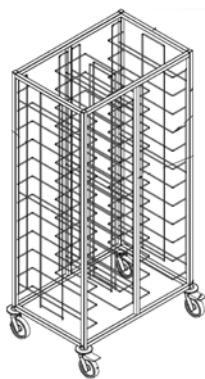

CBA24P

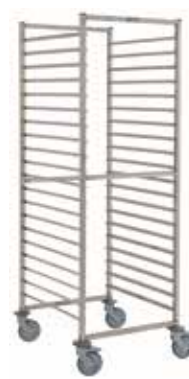

**CBGN 2021
CBGN 2011**



MODELE	PRIX	MESURES [mm]	MATÉRIAUX [°C]
CBA12P		510 x 633 x 1787 mm	AISI 304
CBA24P		925 x 633 x 1787 mm	AISI 304
CBGN 2021 CBGN 2011		660 x 775 x 1787 mm	AISI 304



**CBGN 2021
CBGN 2011**



6

Éléments Neutres

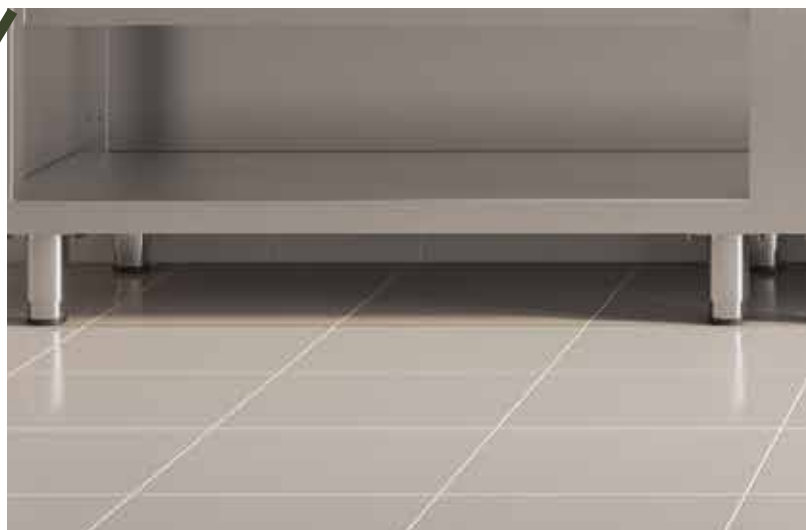



Armoire avec étagères Passage

HAUTEUR 850mm



AVEC PLAN DE



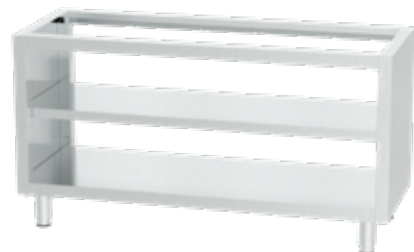

NE15M60801N1 ◀







SANS PLAN DE TRAVAIL

NE15M60801NO ◀

Game 600

    				
AVEC PLAN DE TRAVAIL SANS DOSSERET			SANS PLAN DE TRAVAIL	
MESURES [MM]	MODELE	PRIX €	MODELE	PRIX €
600x600x850	NE60M60801N1		NE60M60801NO	
800x600x850	NE80M60801N1		NE80M60801NO	
1000x600x850	NE10M60801N1		NE10M60801NO	
1200x600x850	NE12M60801N1		NE12M60801NO	
1400x600x850	NE14M60801N1		NE14M60801NO	
1500x600x850	NE15M60801N1		NE15M60801NO	
1600x600x850	NE16M60801N1		NE16M60801NO	
1800x600x850	NE18M60801N1		NE18M60801NO	
2000x600x850	NE20M60801N1		NE20M60801NO	
2200x600x850	NE22M60801N1		NE22M60801NO	
2400x600x850	NE24M60801N1		NE24M60801NO	

Game 700

    				
AVEC PLAN DE TRAVAIL SANS DOSSERET			SANS PLAN DE TRAVAIL	
MESURES [MM]	MODELE	PRIX €	MODELE	PRIX €
600x700x850	NE60M70801N1		NE60M70801NO	
800x700x850	NE80M70801N1		NE80M70801NO	
1000x700x850	NE10M70801N1		NE10M70801NO	
1200x700x850	NE12M70801N1		NE12M70801NO	
1400x700x850	NE14M70801N1		NE14M70801NO	
1500x700x850	NE15M70801N1		NE15M70801NO	
1600x700x850	NE16M70801N1		NE16M70801NO	
1800x700x850	NE18M70801N1		NE18M70801NO	
2000x700x850	NE20M70801N1		NE20M70801NO	
2200x700x850	NE22M70801N1		NE22M70801NO	
2400x700x850	NE24M70801N1		NE24M70801NO	

Armoire avec Étagères Passage

HAUTEUR 600mm

6

Éléments Neutres



NE15M60601N1 ◀

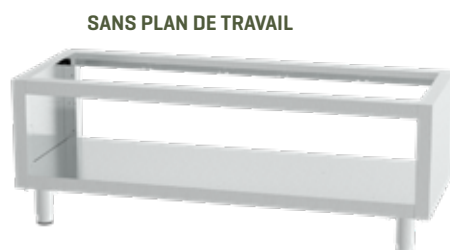

NE15M60601NO ◀

Game 600

MESURES [MM]	AVEC PLAN DE TRAVAIL SANS DOSSERET		SANS PLAN DE TRAVAIL	
	MODELE	PRIX €	MODELE	PRIX €
600x600x600	NE60M60601N1		NE60M60601NO	
800x600x600	NE80M60601N1		NE80M60601NO	
1000x600x600	NE10M60601N1		NE10M60601NO	
1200x600x600	NE12M60601N1		NE12M60601NO	
1400x600x600	NE14M60601N1		NE14M60601NO	
1500x600x600	NE15M60601N1		NE15M60601NO	
1600x600x600	NE16M60601N1		NE16M60601NO	
1800x600x600	NE18M60601N1		NE18M60601NO	
2000x600x600	NE20M60601N1		NE20M60601NO	
2200x600x600	NE22M60601N1		NE22M60601NO	
2400x600x600	NE24M60601N1		NE24M60601NO	

Game 700

MESURES [MM]	AVEC PLAN DE TRAVAIL SANS DOSSERET		SANS PLAN DE TRAVAIL	
	MODELE	PRIX €	MODELE	PRIX €
600x700x600	NE60M70601N1		NE60M70601NO	
800x700x600	NE80M70601N1		NE80M70601NO	
1000x700x600	NE10M70601N1		NE10M70601NO	
1200x700x600	NE12M70601N1		NE12M70601NO	
1400x700x600	NE14M70601N1		NE14M70601NO	
1500x700x600	NE15M70601N1		NE15M70601NO	
1600x700x600	NE16M70601N1		NE16M70601NO	
1800x700x600	NE18M70601N1		NE18M70601NO	
2000x700x600	NE20M70601N1		NE20M70601NO	
2200x700x600	NE22M70601N1		NE22M70601NO	
2400x700x600	NE24M70601N1		NE24M70601NO	

Armoire avec Étagères (avec panneau arrière)

HAUTEUR 850mm

AVEC PLAN DE TRAVAIL ET DOSSERET

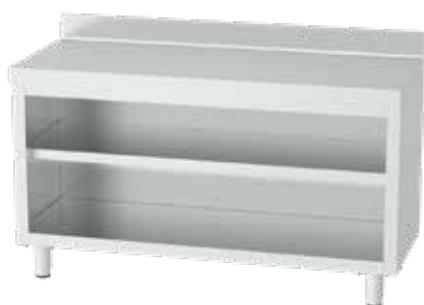

NE15M60803N2 ◀

AVEC PLAN DE TRAVAIL SANS DOSSERET

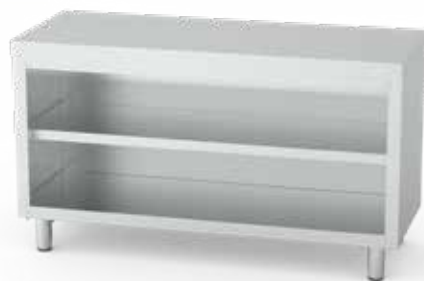

NE15M60803N1 ◀

SANS PLAN DE TRAVAIL



NE15M60803NO ◀

Game 600

MESURES [MM]	AVEC PLAN DE TRAVAIL ET DOSSERET		AVEC PLAN DE TRAVAIL SANS DOSSERET		SANS PLAN DE TRAVAIL	
	MODELE	PRIX €	MODELE	PRIX €	MODELE	PRIX €
600x600x850	NE60M60803N2		NE60M60803N1		NE60M60803NO	
800x600x850	NE80M60803N2		NE80M60803N1		NE80M60803NO	
1000x600x850	NE10M60803N2		NE10M60803N1		NE10M60803NO	
1200x600x850	NE12M60803N2		NE12M60803N1		NE12M60803NO	
1400x600x850	NE14M60803N2		NE14M60803N1		NE14M60803NO	
1500x600x850	NE15M60803N2		NE15M60803N1		NE15M60803NO	
1600x600x850	NE16M60803N2		NE16M60803N1		NE16M60803NO	
1800x600x850	NE18M60803N2		NE18M60803N1		NE18M60803NO	
2000x600x850	NE20M60803N2		NE20M60803N1		NE20M60803NO	
2200x600x850	NE22M60803N2		NE22M60803N1		NE22M60803NO	
2400x600x850	NE24M60803N2		NE24M60803N1		NE24M60803NO	

Game 700

MESURES [MM]	AVEC PLAN DE TRAVAIL ET DOSSERET		AVEC PLAN DE TRAVAIL SANS DOSSERET		SANS PLAN DE TRAVAIL	
	MODELE	PRIX €	MODELE	PRIX €	MODELE	PRIX €
600x700x850	NE60M70803N2		NE60M70803N1		NE60M70803NO	
800x700x850	NE80M70803N2		NE80M70803N1		NE80M70803NO	
1000x700x850	NE10M70803N2		NE10M70803N1		NE10M70803NO	
1200x700x850	NE12M70803N2		NE12M70803N1		NE12M70803NO	
1400x700x850	NE14M70803N2		NE14M70803N1		NE14M70803NO	
1500x700x850	NE15M70803N2		NE15M70803N1		NE15M70803NO	
1600x700x850	NE16M70803N2		NE16M70803N1		NE16M70803NO	
1800x700x850	NE18M70803N2		NE18M70803N1		NE18M70803NO	
2000x700x850	NE20M70803N2		NE20M70803N1		NE20M70803NO	
2200x700x850	NE22M70803N2		NE22M70803N1		NE22M70803NO	
2400x700x850	NE24M70803N2		NE24M70803N1		NE24M70803NO	

Armoire avec Étagères (avec panneau arrière)

HAUTEUR 600mm



AVEC PLAN DE TRAVAIL ET DOSSERET

NE15M60603N2 ◀

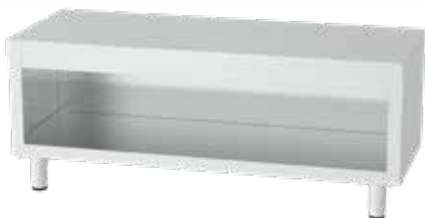

AVEC PLAN DE TRAVAIL SANS DOSSERET

NE15M60603N1 ◀



SANS PLAN DE TRAVAIL

NE15M60603NO ◀

Game 600

MESURES (MM)	AVEC PLAN DE TRAVAIL ET DOSSERET		AVEC PLAN DE TRAVAIL SANS DOSSERET		SANS PLAN DE TRAVAIL	
	MODELE	PRIX €	MODELE	PRIX €	MODELE	PRIX €
600x600x600	NE60M60603N2		NE60M60803N1		NE60M60803NO	
800x600x600	NE80M60603N2		NE80M60603N1		NE80M60603NO	
1000x600x600	NE10M60603N2		NE10M60603N1		NE10M60603NO	
1200x600x600	NE12M60603N2		NE12M60603N1		NE12M60603NO	
1400x600x600	NE14M60603N2		NE14M60603N1		NE14M60603NO	
1500x600x600	NE15M60603N2		NE15M60603N1		NE15M60603NO	
1600x600x600	NE16M60603N2		NE16M60603N1		NE16M60603NO	
1800x600x600	NE18M60603N2		NE18M60603N1		NE18M60603NO	
2000x600x600	NE20M60603N2		NE20M60603N1		NE20M60603NO	
2200x600x600	NE22M60603N2		NE22M60603N1		NE22M60603NO	
2400x600x600	NE24M60603N2		NE24M60603N1		NE24M60603NO	

Game 700

MESURES (MM)	AVEC PLAN DE TRAVAIL ET DOSSERET		AVEC PLAN DE TRAVAIL SANS DOSSERET		SANS PLAN DE TRAVAIL	
	MODELE	PRIX €	MODELE	PRIX €	MODELE	PRIX €
600x700x600	NE60M70603N2		NE60M70603N1		NE60M70603NO	
800x700x600	NE80M70603N2		NE80M70603N1		NE80M70603NO	
1000x700x600	NE10M70603N2		NE10M70603N1		NE10M70603NO	
1200x700x600	NE12M70603N2		NE12M70603N1		NE12M70603NO	
1400x700x600	NE14M70603N2		NE14M70603N1		NE14M70603NO	
1500x700x600	NE15M70603N2		NE15M70603N1		NE15M70603NO	
1600x700x600	NE16M70603N2		NE16M70603N1		NE16M70603NO	
1800x700x600	NE18M70603N2		NE18M70603N1		NE18M70603NO	
2000x700x600	NE20M70603N2		NE20M70603N1		NE20M70603NO	
2200x700x600	NE22M70603N2		NE22M70603N1		NE22M70603NO	
2400x700x600	NE24M70603N2		NE24M70603N1		NE24M70603NO	

Armoire avec Portes Coulissantes Passage

HAUTEUR 850mm

AVEC PLAN DE TRAVAIL SANS DOSSERET

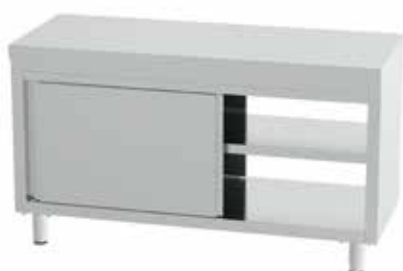

NE15M60802N1 ◀

SANS PLAN DE TRAVAIL



NE15M60802N0 ◀

Game 600



AVEC PLAN DE TRAVAIL SANS DOSSERET		SANS PLAN DE TRAVAIL		
MESURES [MM]	MODELE	PRIX €	MODELE	PRIX €
1000x600x850	NE10M60802N1		NE10M60802N0	
1200x600x850	NE12M60802N1		NE12M60802N0	
1400x600x850	NE14M60802N1		NE14M60802N0	
1500x600x850	NE15M60802N1		NE15M60802N0	
1600x600x850	NE16M60802N1		NE16M60802N0	
1800x600x850	NE18M60802N1		NE18M60802N0	
2000x600x850	NE20M60802N1		NE20M60802N0	
2200x600x850	NE22M60802N1		NE22M60802N0	
2400x600x850	NE24M60802N1		NE24M60802N0	

Game 700



AVEC PLAN DE TRAVAIL SANS DOSSERET		SANS PLAN DE TRAVAIL		
MESURES [MM]	MODELE	PRIX €	MODELE	PRIX €
1000x700x850	NE10M70802N1		NE10M70802N0	
1200x700x850	NE12M70802N1		NE12M70802N0	
1400x700x850	NE14M70802N1		NE14M70802N0	
1500x700x850	NE15M70802N1		NE15M70802N0	
1600x700x850	NE16M70802N1		NE16M70802N0	
1800x700x850	NE18M70802N1		NE18M70802N0	
2000x700x850	NE20M70802N1		NE20M70802N0	
2200x600x850	NE22M70802N1		NE22M70802N0	
2400x600x850	NE24M70802N1		NE24M70802N0	

Armoire avec Portes Coulissantes Passage

HAUTEUR 600mm

6

Éléments Neutres



AVEC PLAN DE TRAVAIL SANS DOSSERET

NE15M60602N1 ◀

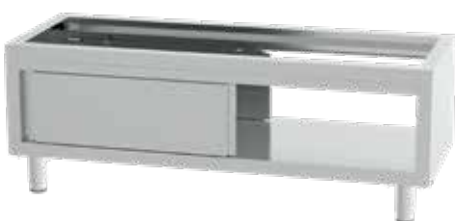

SANS PLAN DE TRAVAIL

NE15M60602NO ◀

Game 600

MESURES [MM]	AVEC PLAN DE TRAVAIL SANS DOSSERET		SANS PLAN DE TRAVAIL	
	MODELE	PRIX €	MODELE	PRIX €
1000x600x600	NE10M60602N1		NE10M60802NO	
1200x600x600	NE12M60602N1		NE12M60602NO	
1400x600x600	NE14M60602N1		NE14M60602NO	
1500x600x600	NE15M60602N1		NE15M60602NO	
1600x600x600	NE16M60602N1		NE16M60602NO	
1800x600x600	NE18M60602N1		NE18M60602NO	
2000x600x600	NE20M60602N1		NE20M60602NO	
2200x600x600	NE22M60602N1		NE22M60602NO	
2400x600x600	NE24M60602N1		NE24M60602NO	

Game 700

MESURES [MM]	AVEC PLAN DE TRAVAIL SANS DOSSERET		SANS PLAN DE TRAVAIL	
	MODELE	PRIX €	MODELE	PRIX €
1000x700x600	NE10M70602N1		NE10M70602NO	
1200x700x600	NE12M70602N1		NE12M70602NO	
1400x700x600	NE14M70602N1		NE14M70602NO	
1500x700x600	NE15M70602N1		NE15M70602NO	
1600x700x600	NE16M70602N1		NE16M70602NO	
1800x700x600	NE18M70602N1		NE18M70602NO	
2000x700x600	NE20M70602N1		NE20M70602NO	
2200x600x600	NE22M70602N1		NE22M70602NO	
2400x600x600	NE24M70602N1		NE24M70602NO	

Armoire avec Portes Coulissantes

HAUTEUR 850mm

AVEC PLAN DE TRAVAIL ET DOSSERET



NE15M60804N2 ◀

AVEC PLAN DE TRAVAIL SANS DOSSERET



NE15M60804N1 ◀

SANS PLAN DE TRAVAIL



NE15M60804N0 ◀

Game 600

MESURES [MM]	AVEC PLAN DE TRAVAIL ET DOSSERET		AVEC PLAN DE TRAVAIL SANS DOSSERET		SANS PLAN DE TRAVAIL	
	MODELE	PRIX €	MODELE	PRIX €	MODELE	PRIX €
1000x600x850	NE10M60804N2		NE10M60804N1		NE10M60804N0	
1200x600x850	NE12M60804N2		NE12M60804N1		NE12M60804N0	
1400x600x850	NE14M60804N2		NE14M60804N1		NE14M60804N0	
1500x600x850	NE15M60804N2		NE15M60804N1		NE15M60804N0	
1600x600x850	NE16M60804N2		NE16M60804N1		NE16M60804N0	
1800x600x850	NE18M60804N2		NE18M60804N1		NE18M60804N0	
2000x600x850	NE20M60804N2		NE20M60804N1		NE20M60804N0	
2200x600x850	NE22M60804N2		NE22M60804N1		NE22M60804N0	
2400x600x850	NE24M60804N2		NE24M60804N1		NE24M60804N0	

Game 700

MESURES [MM]	AVEC PLAN DE TRAVAIL ET DOSSERET		AVEC PLAN DE TRAVAIL SANS DOSSERET		SANS PLAN DE TRAVAIL	
	MODELE	PRIX €	MODELE	PRIX €	MODELE	PRIX €
1000x700x850	NE10M70804N2		NE10M70804N1		NE10M70804N0	
1200x700x850	NE12M70804N2		NE12M70804N1		NE12M70804N0	
1400x700x850	NE14M70804N2		NE14M70804N1		NE14M70804N0	
1500x700x850	NE15M70804N2		NE15M70804N1		NE15M70804N0	
1600x700x850	NE16M70804N2		NE16M70804N1		NE16M70804N0	
1800x700x850	NE18M70804N2		NE18M70804N1		NE18M70804N0	
2000x700x850	NE20M70804N2		NE20M70804N1		NE20M70804N0	
2200x700x850	NE22M70804N2		NE22M70804N1		NE22M70804N0	
2400x700x850	NE24M70804N2		NE24M70804N1		NE24M70804N0	

Armoire avec Portes

HAUTEUR 600mm

6

Éléments Neutres



AVEC PLAN DE TRAVAIL ET DOSSERET

NE15M60604N2



AVEC PLAN DE TRAVAIL SANS DOSSERET

NE15M60604N1



SANS PLAN DE TRAVAIL

NE15M60604N0

Game 600

MESURES [MM]	AVEC PLAN DE TRAVAIL ET DOSSERET		AVEC PLAN DE TRAVAIL SANS DOSSERET		SANS PLAN DE TRAVAIL	
	MODELE	PRIX €	MODELE	PRIX €	MODELE	PRIX €
1000x600x600	NE10M60604N2		NE10M60604N1		NE10M60604N0	
1200x600x600	NE12M60604N2		NE12M60604N1		NE12M60604N0	
1400x600x600	NE14M60604N2		NE14M60604N1		NE14M60604N0	
1500x600x600	NE15M60604N2		NE15M60604N1		NE15M60604N0	
1600x600x600	NE16M60604N2		NE16M60604N1		NE16M60604N0	
1800x600x600	NE18M60604N2		NE18M60604N1		NE18M60604N0	
2000x600x600	NE20M60604N2		NE20M60604N1		NE20M60804N0	
2200x600x600	NE22M60604N2		NE22M60604N1		NE22M60604N0	
2400x600x600	NE24M60604N2		NE24M60604N1		NE24M60604N0	

Game 700

MESURES [MM]	AVEC PLAN DE TRAVAIL ET DOSSERET		AVEC PLAN DE TRAVAIL SANS DOSSERET		SANS PLAN DE TRAVAIL	
	MODELE	PRIX €	MODELE	PRIX €	MODELE	PRIX €
1000x700x600	NE10M70604N2		NE10M70604N1		NE10M70604N0	
1200x700x600	NE12M70604N2		NE12M70604N1		NE12M70604N0	
1400x700x600	NE14M70604N2		NE14M70604N1		NE14M70604N0	
1500x700x600	NE15M70604N2		NE15M70604N1		NE15M70604N0	
1600x700x600	NE16M70604N2		NE16M70604N1		NE16M70604N0	
1800x700x600	NE18M70604N2		NE18M70604N1		NE18M70604N0	
2000x700x600	NE20M70604N2		NE20M70604N1		NE20M70604N0	
2200x700x600	NE22M70604N2		NE22M70604N1		NE22M70604N0	
2400x700x600	NE24M70604N2		NE24M70604N1		NE24M70604N0	

Game 600

MESURES [MM]	AVEC PLAN DE TRAVAIL ET DOSSERET		AVEC PLAN DE TRAVAIL SANS DOSSERET		SANS PLAN DE TRAVAIL	
	MODELE	PRIX €	MODELE	PRIX €	MODELE	PRIX €
600x600x850	NE60M60805N2		NE60M60805N1		NE60M60805NO	
800x600x850	NE80M60805N2		NE80M60805N1		NE80M60805NO	
1000x600x850	NE10M60805N2		NE10M60805N1		NE10M60805NO	
1200x600x850	NE12M60805N2		NE12M60805N1		NE12M60805NO	
1400x600x850	NE14M60805N2		NE14M60805N1			
1500x600x850	NE15M60805N2		NE15M60805N1			
1600x600x850	NE16M60805N2		NE16M60805N1			
1800x600x850	NE18M60805N2		NE18M60805N1			
2000x600x850	NE20M60805N2		NE20M60805N1			
2200x600x850	NE22M60805N2		NE22M60805N1			
2400x600x850	NE24M60805N2		NE24M60805N1			

AVEC PLAN DE TRAVAIL ET DOSSERET



NE15M60805N2 ◀

AVEC PLAN DE TRAVAIL SANS DOSSERET



NE15M60805N1 ◀

SANS PLAN DE TRAVAIL



NE15M60805NO ◀

Game 700

MESURES [MM]	AVEC PLAN DE TRAVAIL ET DOSSERET		AVEC PLAN DE TRAVAIL SANS DOSSERET		SANS PLAN DE TRAVAIL	
	MODELE	PRIX €	MODELE	PRIX €	MODELE	PRIX €
600x700x850	NE60M70805N2		NE60M70805N1		NE60M70805NO	
800x700x850	NE80M70805N2		NE80M70805N1		NE80M70805NO	
1000x700x850	NE10M70805N2		NE10M70805N1		NE10M70805NO	
1200x700x850	NE12M70805N2		NE12M70805N1		NE12M70805NO	
1400x700x850	NE14M70805N2		NE14M70805N1			
1500x700x850	NE15M70805N2		NE15M70805N1			
1600x700x850	NE16M70805N2		NE16M70805N1			
1800x700x850	NE18M70805N2		NE18M70805N1			
2000x700x850	NE20M70805N2		NE20M70805N1			
2200x700x850	NE22M70805N2		NE22M70805N1			
2400x700x850	NE24M70805N2		NE24M70805N1			

Portes à Charnières

HAUTEUR 600mm

Game 600

MESURES [MM]	AVEC PLAN DE TRAVAIL ET DOSSERET		AVEC PLAN DE TRAVAIL SANS DOSSERET		SANS PLAN DE TRAVAIL	
	MODELE	PRIX €	MODELE	PRIX €	MODELE	PRIX €
600x600x600	NE60M60605N2		NE60M60605N1		NE60M60805N0	
800x600x600	NE80M60605N2		NE80M60605N1		NE80M60605N0	
1000x600x600	NE10M60605N2		NE10M60605N1		NE10M60605N0	
1200x600x600	NE12M60605N2		NE12M60605N1		NE12M60605N0	
1400x600x600	NE14M60605N2		NE14M60605N1			
1500x600x600	NE15M60605N2		NE15M60605N1			
1600x600x600	NE16M60605N2		NE16M60605N1			
1800x600x600	NE18M60605N2		NE18M60605N1			
2000x600x600	NE20M60605N2		NE20M60605N1			
2200x600x600	NE22M60605N2		NE22M60605N1			
2400x600x600	NE24M60605N2		NE24M60605N1			

AVEC PLAN DE TRAVAIL ET DOSSERET



NE15M60605N2

AVEC PLAN DE TRAVAIL SANS DOSSERET



NE15M60605N1

SANS PLAN DE TRAVAIL

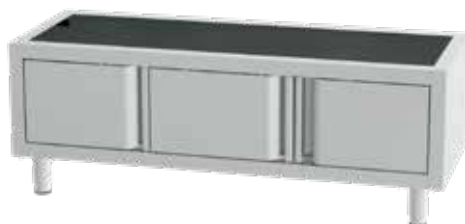

NE15M60605N0

Game 700

MESURES [MM]	AVEC PLAN DE TRAVAIL ET DOSSERET		AVEC PLAN DE TRAVAIL SANS DOSSERET		SANS PLAN DE TRAVAIL	
	MODELE	PRIX €	MODELE	PRIX €	MODELE	PRIX €
600x700x600	NE60M70605N2		NE60M70805N1		NE60M70805N0	
800x700x600	NE80M70605N2		NE80M70605N1		NE80M70605N0	
1000x700x600	NE10M70605N2		NE10M70605N1		NE10M70605N0	
1200x700x600	NE12M70605N2		NE12M70605N1		NE12M70605N0	
1400x700x600	NE14M70605N2		NE14M70605N1			
1500x700x600	NE15M70605N2		NE15M70605N1			
1600x700x600	NE16M70605N2		NE16M70605N1			
1800x700x600	NE18M70605N2		NE18M70605N1			
2000x700x600	NE20M70605N2		NE20M70605N1			
2200x700x600	NE22M70605N2		NE22M70605N1			
2400x700x600	NE24M70605N2		NE24M70605N1			

Plans de Travail

AVEC PLAN DE TRAVAIL ET DOSSERET



NE15E60018N2 ◀

AVEC PLAN DE TRAVAIL SANS DOSSERET



NE15E60018N1 ◀

Game 600



MESURES [MM]	AVEC PLAN DE TRAVAIL ET DOSSERET		AVEC PLAN DE TRAVAIL SANS DOSSERET	
	MODELE	RIX €	MODELE	RIX €
400	NE04E60018N2		NE04E60018N1	
500	NE05E60018N2		NE05E60018N1	
600	NE06E60018N2		NE06E60018N1	
700	NE07E60018N2		NE07E60018N1	
800	NE08E60018N2		NE08E60018N1	
900	NE09E60018N2		NE09E60018N1	
1000	NE10E60018N2		NE10E60018N1	
1100	NE11E60018N2		NE11E60018N1	
1200	NE12E60018N2		NE12E60018N1	
1300	NE13E60018N2		NE13E60018N1	
1400	NE14E60018N2		NE14E60018N1	
1500	NE15E60018N2		NE15E60018N1	
1600	NE16E60018N2		NE16E60018N1	
1700	NE17E60018N2		NE17E60018N1	
1800	NE18E60018N2		NE18E60018N1	
1900	NE19E60018N2		NE19E60018N1	
2000	NE20E60018N2		NE20E60018N1	
2100	NE21E60018N2		NE21E60018N1	
2200	NE22E60018N2		NE22E60018N1	
2300	NE23E60018N2		NE23E60018N1	
2400	NE24E60018N2		NE24E60018N1	
2500	NE25E60018N2		NE25E60018N1	
2600	NE26E60018N2		NE26E60018N1	
2700	NE27E60018N2		NE27E60018N1	
2800	NE28E60018N2		NE28E60018N1	

Plans de Travail

Game 700



MESURES [MM]	AVEC PLAN DE TRAVAIL ET DOSSERET		AVEC PLAN DE TRAVAIL SANS DOSSERET	
	MODELE	PRIX €	MODELE	PRIX €
400	NE04E70018N2		NE04E70018N1	
500	NE05E70018N2		NE05E70018N1	
600	NE06E70018N2		NE06E70018N1	
700	NE07E70018N2		NE07E70018N1	
800	NE08E70018N2		NE08E70018N1	
900	NE09E70018N2		NE09E70018N1	
1000	NE10E70018N2		NE10E70018N1	
1100	NE11E70018N2		NE11E70018N1	
1200	NE12E70018N2		NE12E70018N1	
1300	NE13E70018N2		NE13E70018N1	
1400	NE14E70018N2		NE14E70018N1	
1500	NE15E70018N2		NE15E70018N1	
1600	NE16E70018N2		NE16E70018N1	
1700	NE17E70018N2		NE17E70018N1	
1800	NE18E70018N2		NE18E70018N1	
1900	NE19E70018N2		NE19E70018N1	
2000	NE20E70018N2		NE20E70018N1	
2100	NE21E70018N2		NE21E70018N1	
2200	NE22E70018N2		NE22E70018N1	
2300	NE23E70018N2		NE23E70018N1	
2400	NE24E70018N2		NE24E70018N1	
2500	NE25E70018N2		NE25E70018N1	
2600	NE26E70018N2		NE26E70018N1	
2700	NE27E70018N2		NE27E70018N1	
2800	NE28E70018N2		NE28E70018N1	

AVEC PLAN DE TRAVAIL ET DOSSERET



NE15E70018N2 ◀

AVEC PLAN DE TRAVAIL SANS
DOSSERET



NE15E70018N1 ◀

Ouvert 1 côté et 3 tiroirs

Tiroirs à droite

AVEC PLAN DE TRAVAIL ET DOSSERET

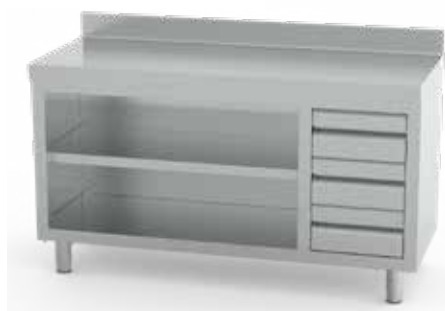

NE15M60808D2 ◀

AVEC PLAN DE TRAVAIL SANS DOSSERET



NE12M60808D1 ◀

Game 600



MESURES [MM]	AVEC DOSSERET		SANS DOSSERET	
	MODELE	PRIX	MODELE	PRIX
1200x600x850	NE12M60808D2		NE12M60808D1	
1400x600x850	NE14M60808D2		NE14M60808D1	
1500x600x850	NE15M60808D2		NE15M60808D1	
1600x600x850	NE16M60808D2		NE16M60808D1	
1800x600x850	NE18M60808D2		NE18M60808D1	
2000x600x850	NE20M60808D2		NE20M60808D1	
2200x600x850	NE22M60808D2		NE22M60808D1	
2400x600x850	NE24M60808D2		NE24M60808D1	

Game 700



MESURES [MM]	AVEC DOSSERET		SANS DOSSERET	
	MODELE	PRIX	MODELE	PRIX
1200x700x850	NE12M70808D2		NE12M70808D1	
1400x700x850	NE14M70808D2		NE14M70808D1	
1500x700x850	NE15M70808D2		NE15M70808D1	
1600x700x850	NE16M70808D2		NE16M70808D1	
1800x700x850	NE18M70808D2		NE18M70808D1	
2000x700x850	NE20M70808D2		NE20M70808D1	
2200x700x850	NE22M70808D2		NE22M70808D1	
2400x700x850	NE24M70808D2		NE24M70808D1	

Ouvrir 1 côté et 3 tiroirs

Tiroirs à gauche

AVEC PLAN DE TRAVAIL ET DOSSERET



NE15M6080812 ◀

Game 600

MESURES [MM]	AVEC DOSSERET		SANS DOSSERET	
	MODELE	PRIX €	MODELE	PRIX €
1200x600x850	NE12M60808I2		NE12M60808I1	
1400x600x850	NE14M60808I2		NE14M60808I1	
1500x600x850	NE15M60808I2		NE15M60808I1	
1600x600x850	NE16M60808I2		NE16M60808I1	
1800x600x850	NE18M60808I2		NE18M60808I1	
2000x600x850	NE20M60808I2		NE20M60808I1	
2200x600x850	NE22M60808I2		NE22M60808I1	
2400x600x850	NE24M60808I2		NE24M60808I1	

AVEC PLAN DE TRAVAIL SANS DOSSERET



NE15M6080811 ◀

Game 700

MESURES [MM]	AVEC DOSSERET		AVEC PLAN DE TRAVAIL SANS DOSSERET	
	MODELE	PRIX €	MODELE	PRIX €
1200x700x850	NE12M70808I2		NE12M70808I1	
1400x700x850	NE14M70808I2		NE14M70808I1	
1500x700x850	NE15M70808I2		NE15M70808I1	
1600x700x850	NE16M70808I2		NE16M70808I1	
1800x700x850	NE18M70808I2		NE18M70808I1	
2000x700x850	NE20M70808I2		NE20M70808I1	
2200x700x850	NE22M70808I2		NE22M70808I1	
2400x700x850	NE24M70808I2		NE24M70808I1	

Coulisseaux 1 côté et 3 tiroirs

Tiroirs à droite

AVEC PLAN DE TRAVAIL ET DOSSERET



NE15M60809D2 ◀

AVEC PLAN DE TRAVAIL SANS DOSSERET



NE15M60809D1 ◀

Game 600



MESURES [MM]	AVEC DOSSERET		SANS DOSSERET	
	MODELE	PRIX €	MODELE	PRIX €
1200x600x850	NE12M60809D2		NE12M60809D1	
1400x600x850	NE14M60809D2		NE14M60809D1	
1500x600x850	NE15M60809D2		NE15M60809D1	
1600x600x850	NE16M60809D2		NE16M60809D1	
1800x600x850	NE18M60809D2		NE18M60809D1	
2000x600x850	NE20M60809D2		NE20M60809D1	
2200x600x850	NE22M60809D2		NE22M60809D1	
2400x600x850	NE24M60809D2		NE24M60809D1	

Game 700



MESURES [MM]	AVEC DOSSERET		SANS DOSSERET	
	MODELE	PRIX €	MODELE	PRIX €
1200x700x850	NE12M70809D2		NE12M70809D1	
1400x700x850	NE14M70809D2		NE14M70809D1	
1500x700x850	NE15M70809D2		NE15M70809D1	
1600x700x850	NE16M70809D2		NE16M70809D1	
1800x700x850	NE18M70809D2		NE18M70809D1	
2000x700x850	NE20M70809D2		NE20M70809D1	
2200x700x850	NE22M70809D2		NE22M70809D1	
2400x700x850	NE24M70809D2		NE24M70809D1	

Coulisseaux 1 côté et 3 tiroirs

Tiroirs à Gauche

AVEC PLAN DE TRAVAIL ET DOSSERET



NE15M60809I2 ◀

Game 600



Game 600				
AVEC DOSSERET			SANS DOSSERET	
MESURES (MM)	MODELE	PRIX €	MODELE	PRIX €
1200x600x850	NE12M60809I2		NE12M60809I1	
1400x600x850	NE14M60809I2		NE14M60809I1	
1500x600x850	NE15M60809I2		NE15M60809I1	
1600x600x850	NE16M60809I2		NE16M60809I1	
1800x600x850	NE18M60809I2		NE18M60809I1	
2000x600x850	NE20M60809I2		NE20M60809I1	
2200x600x850	NE22M60809I2		NE22M60809I1	
2400x600x850	NE24M60809I2		NE24M60809I1	

AVEC PLAN DE TRAVAIL SANS DOSSERET

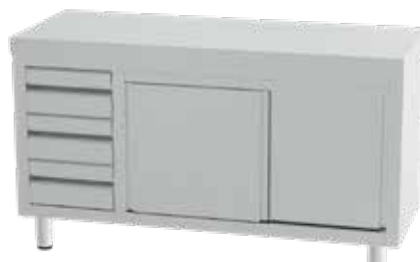

NE15M60809I1 ◀

Game 700



Game 700				
AVEC DOSSERET			SANS DOSSERET	
MESURES (MM)	MODELE	PRIX €	MODELE	PRIX €
1200x700x850	NE12M70809I2		NE12M70809I1	
1400x700x850	NE14M70809I2		NE14M70809I1	
1500x700x850	NE15M70809I2		NE15M70809I1	
1600x700x850	NE16M70809I2		NE16M70809I1	
1800x700x850	NE18M70809I2		NE18M70809I1	
2000x700x850	NE20M70809I2		NE20M70809I1	
2200x700x850	NE22M70809I2		NE22M70809I1	
2400x700x850	NE24M70809I2		NE24M70809I1	

Distributeurs de Pain, de Verre et de Coupe Modèles

Couteau et Pain en Boîte



EEPN

MODELE	MESURES [MM]	PRIX €
EEPN	620 x 650 x 690	

Distributeurs de Pain, de Coupes en Verre et de Couverts



SSPN620



SSPN



SSPN800



SSPN1400



SSEST620

MODELE	MESURES [MM]	PRIX €
SSPN620	620 x 700 x 1500	
SSPN	620 x 650 x 450	
SSPN800	800 x 700 x 1500	
SSPN1400	1400x 700 x 1500	
SSEST620	620 x 700 x 1360	



SSPN1400



SSEST620



SSPN800



Accessoires



Robinets de Douche

Gamme Complète de Robinets de Douche

Modèles



GF002



GF003



GF0012



GF013



GF014



GF015



GF016



GF017



GF018



GF019



GF020



GF021



GF022



GF023

- **Fabriqué en laiton chromé épais et de haute densité.**
- **Comprend un régulateur de débit et un clapet anti-retour.**
- **Lignes flexibles et accessoires pour l'installation.**

MODÈLES	DESCRIPTION	PVP
GF002	Mitigeur monotrou h=440mm avec bec pivotant et douchette à double jet pour usage domestique/bar	
GF003	Mélangeur monotrou h=445mm avec bec pivotant, convient pour un usage domestique/bar	
GF012	Kit douche avec ressort, flexible, jonction en laiton et poignée de douche de base	
GF013	Kit de ducha con muelle, flexo, empalme de latón y mango de ducha premium	
GF014	Unité de pré-rinçage monotrou avec poignée ronde et douchette de base	
GF015	Unité de pré-rinçage monotrou avec poignée ronde et poignée de douche premium	
GF016	Mélangeur monotrou pré-rinçage avec bec mobile, levier clinique en plastique (pa6) et douchette de base	
GF017	Mélangeur monotrou pré-rinçage avec bec mobile, levier clinique en plastique (pa6) et main de douche premium	
GF018	Mélangeur monotrou pré-rinçage avec manette courte chromée, version mini	
GF019	Unité de pré-rinçage monotrou avec béquille, version mini	
GF020	Unité de pré-rinçage monotrou avec bec au milieu du tube, poignée étoile chromée et poignée de douche de base	
GF021	Unité de pré-rinçage monotrou avec bec au milieu du tube, poignée étoile chromée et poignée de douche premium	
GF022	Unité de pré-rinçage à deux trous montée au mur avec bec pivotant au milieu d'un tube métallique, poignée ronde et main de douche de base. Empattement de 150 mm avec une tolérance de ±20 mm	
GF023	Unité de pré-rinçage à deux trous montée au mur avec bec pivotant au milieu d'un tube métallique, poignée ronde et main de douche de base. Empattement de 150 mm avec une tolérance de ±20 mm	

Robinetterie industrielle · Accessoires · Kit



GF001



GF004



GF005



GF006



GF007



GF008



GF009



GF010



GF011

Accessories



GF024



GF026



GF027



GF028

Kit



GF029



GF030



GF031



GF032

Robinetterie industrielle · Accessoires · Kit

CODE	DESCRIPCIÓN	PVP €
GF001	Bec chromé en "u" +e3:e26ø18x180	
GF004	Robinet monotrou bec "c" ø18x250, poignée étoile	
GF005	Mitigeur monotrou avec levier clinique en plastique (pa6), bec pivotant et douchette extractible	
GF006	Mitigeur monotrou avec levier clinique en plastique (pa6) et bec pivotant	
GF007	Mélangeur monotrou avec levier clinique en plastique (pa6), bec pivotant longueur 215mm	
GF008	Mezclador de un agujero con palanca clínica de plástico (pa6), pico pivotante longitud 320mm	
GF009	Robinet à deux trous avec bec pivotant en "c" ø18x300, poignée ronde. Empattement de 155 mm	
GF010	Robinet mural à deux trous avec bec pivotant en "s" ø18x300, poignée ronde. Empattement de 150 mm	
GF011	Robinet mural à deux trous avec bec pivotant en "c" ø20x300, poignée ronde. Empattement 203,20mm	
GF024	EErouleur mural - 5m avec pistolet nito	
GF026	Enrouleur de tuyau mural - 5m - pistolet nito	
GF027	Mélangeur à pied monté au sol avec dispositif de verrouillage	
GF028	Mélangeur progressif à pied monté au sol	
GF029	Kit robinet à pied eau froide avec bec en "u" pivotant ø18x180	
GF030	Kit mélangeur progressif à pied avec bec pivotant "u" ø18x250	
GF031	Kit mitigeur à pédale avec bec en "u" pivotant ø18x180	
GF032	Kit mitigeur progressif à pédale avec dispositif de verrouillage, bec en "u" pivotant ø18x180	

Chariots et Stockage

CODE	DESCRIPTION	PVP €
4900x0001	Support de plaque réglable série s /4 tours couleur grise	
4900x0002	Pack 4 tours réglables pour chariot 4900x0001	
4900x0003	Chariot de service léger avec seaux 62 x 40 cm - 96.5 X 41 x 83.5 Cm noir	
4900x0004	Chariot de service léger avec seaux 80 x 52 cm - 101,5 x 54 x 95 cm noir	
4900x0005	Chariot de service Cart pro noir	
4900x0006	Boîtier de connexion rapide de petite taille couleur noire	
4900x0007	Grand seau à connexion rapide noir	
4900x0008	Chariots alimentaires gn 1/1 pour 18 plateaux 1/1	
4900x0009	Chariots alimentaires gn 2/1 Chariot pour 36 plateaux 1/1 Cartouches de vinyle de taille complète pour voiture 1/1	
4900x0010	Cartouches de vinyle de taille complète pour voiture 1/1	
4900x0011	Boîtes à vin de taille complète pour la voiture 2/1 Housses en vinyle pleine grandeur pour le chariot gn 2/1	



4900x0001



4900x0002



4900x0003



4900x0004

Chariots et Stockage



4900x0005



4900x0006



4900x0007



4900x0008



4900x0009



4900x0010



4900x0011

Étagères

SECTION	CODE	DESCRIPTION	PVP €
ETAGERE	4800X0001	Etagère mer 3 étages 6 trous scotch (pour 24*24cm)	
ETAGERE	4800X0002	Tablettes 3 niveaux 16 (pour 14x14, 10x10 et 24x24cm)	
ETAGERE	4800X0003	Buffet verre 2 étages nostalgie [62*35*h:20 cm]	
ETAGERE	4800X0004	Buffet en verre 3 étages [60*40*h:48 cm]	
ETAGERE	4800X0005	Unité de sculpture ø50 h:64 (avec chambre à lampe) [démontée]	
ETAGERE	4800X0006	Lampe à chaleur platine cuadrado 50x50 h:64 Unité de sculpture 50*50 h:64 (avec chambre à lampe) [démontée]	
ETAGERE	4800X0023	Porte-cuillère sea 3 floor 3 trous (récipient ø:13cm h:14cm)	
ETAGERE	4800X0024	Soporte basico 25x12,5 h:9cm Porte-cuillèrei - chaise 25*12,5h:9cm	



4800x0001



4800x0002



4800x0003
4800x0004



4800x0005



4800x0006



4800x0023



4800x0024

Chafing

SECTION	CODE	DESCRIPTION	PVP €
CHAFING	4800X0009	Chafing dish gn 1/1 9lt électrique	
CHAFING	4800X0010	Chafing dish gn 1/1 9lt jelly	
CHAFING	4800X0020	Chafing de cristal gn1/1 hidráulico	
CHAFING	4800X0021	Résistance aux frottements Chauffage électrique 750w 250v	
CHAFING	4800X0022	Chafing de cristal gn 2/3 hidráulico	



4800x0009



4800x0020



4800x0010



4800x0021



4800x0022

Distributeurs

SECTION	CODE	DESCRIPTION	PVP €
DISTRIBUTEURS	4800X0011	Distributeur de miel Lego Verre vertical 4,7 litres H:57,5 cm	
DISTRIBUTEURS	4800X0013	Distributeur de céréales simple	
DISTRIBUTEURS	4800X0014	Distributeur de céréales double	
DISTRIBUTEURS	4800X0015	Distributeur de céréales triple	
DISTRIBUTEURS	4800X0016	Distributeur de jus de fruits 7 Lt	
DISTRIBUTEURS	4800X0017	Distributeur de jus de fruits Double 7*2 Lt	
DISTRIBUTEURS	4800X0018	Distributeur de lait simple 7 litres	
DISTRIBUTEURS	4800X0019	Distributeur de chaleur (pour le café, le thé ou le lait)	



4800x0013



4800x0015



4800x0014



4800x0016



4800x0017



4800x0018



4800x0019



4800x0011

Installations



Instalations



Délégations France



INFRICO .fr ZAC des Portes d L'Océane OUEST.
72650 SAINT SATURNIN (FRANCE)
02 43 42 00 33 • 02 43 42 28 07

Direction
Roberto Doval: 00 34 606 970 357
rdoval@infrico.com

Direction Commercial
Jerome Crespel:
06 08 64 39 76
jerome@infrico.com

Gestion Administrative
Sophia Choukri:
06 58 04 33 15
sophia@infrico.com

Service Compatibilité et Facturation
Valerie Simon:
07 61 98 47 50
02 43 42 00 33
comptabilite@infrico.com

Service SAV
Stephane Vivet:
Pièces détachées
02 53 49 17 23
pieces@infrico.com
Miguel Burgos: SAV
02 53 49 17 22
sav@infrico.com

SECTEUR 1 Paris - Île de France

Gaetan Beneteau:
gaetan@infrico.com
commercial@infrico.com
Tél: 02 43 42 00 33

SECTEUR 2 Nord-Ouest

Jerome Crespel:
jerome@infrico.com
Tél: 06 08 64 39 76

SECTEUR 3 Nord-Est

Solène Haiba
solene@infrico.com
commercial@infrico.com
Tél: 02 43 42 00 33

SECTEUR 4 Sud Est - Monaco

Claire Bonhome:
claire@infrico.com
commercial@infrico.com
Tél: 02 43 42 00 33

SECTEUR 5 Sud Ouest - Corse

Vincent Lecocq:
vincent@infrico.com
Tél: 07 72 77 49 65

OUTRE MER - 6 La Martinique, Guadeloupe, La Réunion, Mayotte, La Guyane, Nouvelle Calédonie

Sophia Choukri
sophia@infrico.com
Tél: 06 58 04 33 15

Valable pour tout le catalogue:
Prix valables sauf en cas d'erreur typographique ou de changement de tarif.
Étiquette énergétique disponible dans les fiches produits sur notre site fribuffet.com
Photos non contractuelles
Les caractéristiques techniques et la conception peuvent être sujettes à modifications, sans préavis.
Les données techniques peuvent varier et seront actualisées dans les fiches techniques du produit, disponibles sur le site www.infrico.com

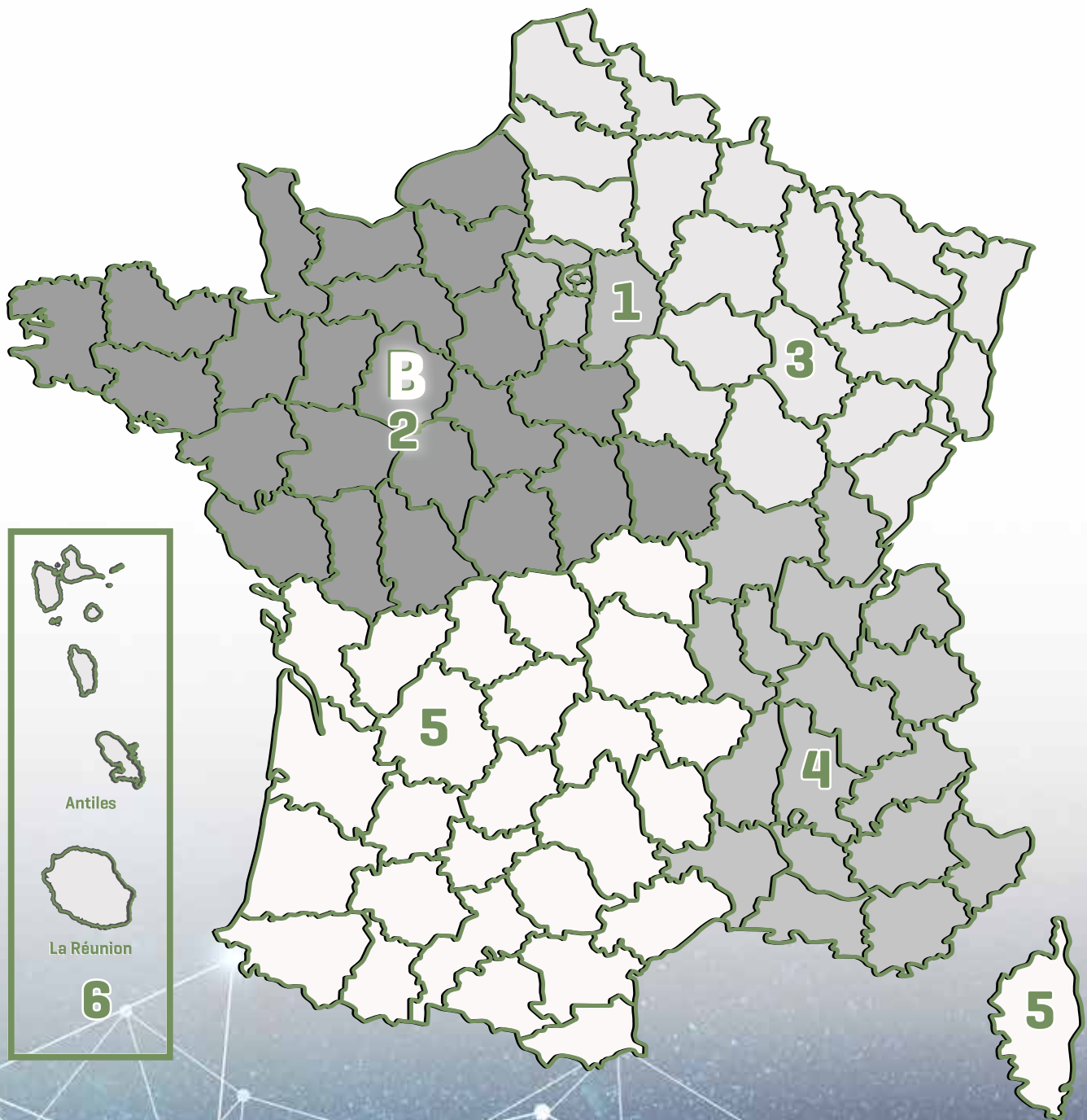

Délégations Internationales

🇺🇸 NORTH AMERICA

Pedro Carvajal
+34 690 23 44 78
pcarvajal@infrico.com

🇺🇸 INFRICO USA

Gigi Oyola
1.855.340.4637
sales@infrico.com

🇲🇽 MÉXICO

Francisco Pedroche
Sinergias
+33 3630 4547
+33 3615 7926
ventas@sinergiasmx.com

🇲🇵 LATINOAMÉRICA

Efraín Onieva
+ 34 686 09 12 41
eonieva@infrico.com

🇩🇴 REPÚBLICA DOMINICANA

Rafael Podadera
Parlyn Internacional
+ 18097594424
podadera.rafael@gmail.com

🇪🇨 ECUADOR / PERÚ / BOLIVIA

Giovanni Pedrazzoli
+59 399 118 6962
gpdrzzoli@infrico.com

🇨🇴 COLOMBIA

Fernando Toro López
+57 313 452 1306
ftoro@infrico.com

🇨🇱 CHILE

Josué Meléndez
Comercial Maquinet
+56 9 8199 3973
ventas@maquinet.cl

🇪🇺 NORTH EUROPE

Juan Carlos Fernández
+34 620 000 938
jcfernandez@infrico.com

🇪🇺 CENTRAL / EAST EUROPE

Dragan Cerkez
+34 608 808 971
dragan@infrico.com

🇧🇪 BENELUX / UK

Mark Botwright
+34 679 71 93 26
mark@infrico.com

🇨🇭 SUIZA / SWITZERLAND

Remzi Alili
Resan Enfrico Sàrl
+ 41 79 589 32 01
+ 41 21 671 70 70
resanenfrico@resanenfrico.ch

🇵🇹 PORTUGAL

Rui Vigo
Unipessoal Lda. Rui Vigo
+ 351 915 283 253
+ 351 309 955 122
rui.vigo@netcabo.pt

🇲🇪 MIDDLE EAST / UAE DUBAI / INDIA

Sushil Hiranandani
+971528 496385
middle-east@infrico.com

🇲🇦 INFRICO MAROC / ÁFRICA / ARABIA SAUDI

Aziz Bouhartan
+ 212 661 107 372
+ 212 522 207 372
aziz.bouhartan@infrico.com

🇿🇦 SOUTH AFRICA

Culinary
+27 [0] 11 701 2200
info@culinary.co.za

🇹🇷 TURKEY / ASIA OCC

Zeynep Onukar
+ 90 554 712 9784
zeynep@infrico.com

🇦🇸 ASIA

Juan Carlos Fernández
+34 620 000 938
jcfernandez@infrico.com

🇸🇪 SOUTH-EAST ASIA

Roberto Doval
+34 606 970 357
rdoval@infrico.com

🇪🇸 INFRICO ESPAGNE

Ctra. de Aguilar a A-318
por Moriles, km 15,5 - A-3132
CP 14900 LUCENA,
Córdoba - España
+ 0034 957 51 30 68
info@fribuffet.com

Valable pour tout le catalogue:

Prix valables sauf en cas d'erreur typographique ou de changement de tarif.

Étiquette énergétique disponible dans les fiches produits sur notre site fribuffet.com

Photos non contractuelles

Les caractéristiques techniques et la conception peuvent être sujettes à modifications, sans préavis.

Les données techniques peuvent varier et seront actualisées dans les fiches techniques du produit, disponibles sur le site www.fribuffet.com

friBuffet 20/23

friBuffet

ZAC des Portes d L'Océane OUEST.
72650 SAINT SATURNIN - FRANCE
02 43 42 00 33 · 02 43 42 28 07
info@fribuffet.com



www.fribuffet.com

GRUPO 
Infrico®